

ALPHA2

Installation and operating instructions



Original installation and operating instructions

These installation and operating instructions describe ALPHA2.

Sections 1-4 give the information necessary to be able to unpack, install and start up the product in a safe way.

Sections 5-12 give important information about the product, as well as information on service, fault finding and disposal of the product.

CONTENTS

	Page
1. General information	2
1.1 Hazard statements	2
1.2 Notes	3
2. Receiving the product	3
2.1 Inspecting the product	3
2.2 Scope of delivery	3
3. Installing the product	3
3.1 Mechanical installation	4
3.2 Pump positions	4
3.3 Control box positions	4
3.4 Insulating the pump housing	5
3.5 Electrical installation	6
3.6 Assembling the plug	6
4. Starting up the product	7
4.1 Before startup	7
4.2 First startup	7
4.3 Venting the pump	7
5. Product introduction	8
5.1 Product description	8
5.2 Intended use	8
5.3 Pumped liquids	8
5.4 Identification	9
5.5 Accessories	10
5.6 Insulating shells, ALPHA2	11
5.7 ALPHA plugs	11
5.8 ALPHA Reader	11
6. Control modes	12
6.1 AUTO _{ADAPT}	12
6.2 Proportional-pressure mode	12
6.3 Constant-pressure mode	12
6.4 Constant curve/constant speed	12
6.5 Automatic night setback	12
6.6 Guide to control mode selection	12
6.7 Pump performance	13
7. Setting the product	14
7.1 Elements on the operating panel	14
7.2 Display	14
7.3 Light fields indicating the pump setting	14
7.4 Button for enabling or disabling of automatic night setback	15
7.5 Button for selection of pump setting	15
7.6 Setting automatic night setback	15
7.7 Setting manual summer mode	15
7.8 Dry-running protection	15
7.9 Using ALPHA Reader	16
8. Servicing the product	17
8.1 Dismantling the product	17
8.2 Dismantling the plug	17
9. Fault finding the product	18
9.1 High-torque start	18
9.2 Fault finding table	18
10. Technical data	19
10.1 Dimensions, ALPHA2 XX-40, XX-50, XX-60, XX-80	20
11. Performance curves	21
11.1 Guide to performance curves	21
11.2 Curve conditions	21
11.3 Performance curves, ALPHA2 XX-40 (N)	22
11.4 Performance curves, ALPHA2 XX-50 (N)	23
11.5 Performance curves, ALPHA2 XX-60 (N)	24

11.6 Performance curves, ALPHA2 XX-80 (N) 25

12. Disposing of the product 25

Read this document and the quick guide before installing the product. Installation and operation must comply with local regulations and accepted codes of good practice.

This appliance can be used by children aged from 8 years and above and persons with reduced physical, sensory or mental capabilities or lack of experience and knowledge if they have been given supervision or instruction concerning use of the appliance in a safe way and understand the hazards involved.

Children shall not play with the appliance. Cleaning and user maintenance shall not be made by children without supervision.

**1. General information****1.1 Hazard statements**

The symbols and hazard statements below may appear in Grundfos installation and operating instructions, safety instructions and service instructions.

**DANGER**

Indicates a hazardous situation which, if not avoided, will result in death or serious personal injury.

**WARNING**

Indicates a hazardous situation which, if not avoided, could result in death or serious personal injury.

**CAUTION**

Indicates a hazardous situation which, if not avoided, could result in minor or moderate personal injury.

The hazard statements are structured in the following way:

**SIGNAL WORD****Description of hazard**

Consequence of ignoring the warning.

- Action to avoid the hazard.

1.2 Notes

The symbols and notes below may appear in Grundfos installation and operating instructions, safety instructions and service instructions.



Observe these instructions for explosion-proof products.



A blue or grey circle with a white graphical symbol indicates that an action must be taken.



A red or grey circle with a diagonal bar, possibly with a black graphical symbol, indicates that an action must not be taken or must be stopped.



If these instructions are not observed, it may result in malfunction or damage to the equipment.



Tips and advice that make the work easier.

2. Receiving the product

2.1 Inspecting the product

Check that the product received is in accordance with the order. Check that the voltage and frequency of the product match voltage and frequency of the installation site. See section [5.4.2 Nameplate](#).

2.2 Scope of delivery

The box contains the following items:

- ALPHA2 pump
- ALPHA plug
- insulating shells
- two gaskets
- quick guide.

3. Installing the product

WARNING

Electric shock

Death or serious personal injury
- Switch off the power supply before starting any work on the product. Make sure that the power supply cannot be accidentally switched on.



CAUTION

Crushing of feet

Minor or moderate personal injury
- Wear safety shoes when opening the box and handling the product.



The pump must always be installed with a horizontal motor shaft within $\pm 5^\circ$.

3.1 Mechanical installation

3.1.1 Mounting the product

The arrows on the pump housing indicate the flow direction through the pump. See fig. 1 (A).

1. Fit the two gaskets supplied with the pump when you mount the pump in the pipe. See fig. 1 (B).
2. Install the pump with a horizontal motor shaft within $\pm 5^\circ$. See fig. 1 (C). See also section 3.2 *Pump positions*.
3. Tighten the fittings.

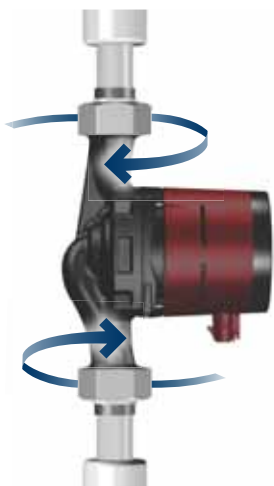
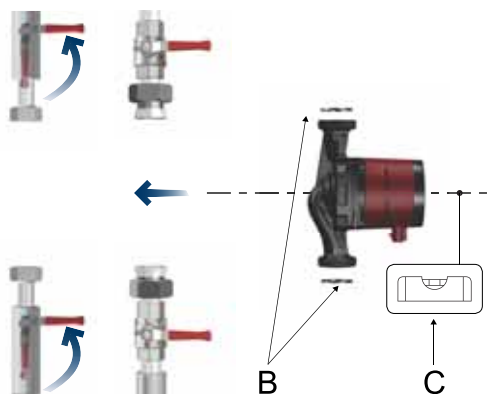
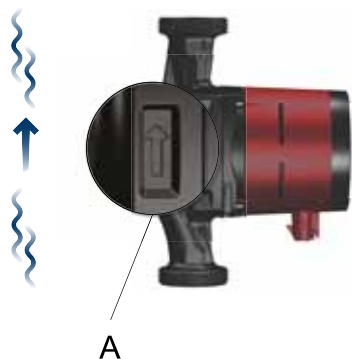

Fig. 1 Mounting ALPHA2

TM07 1193 2119

3.2 Pump positions

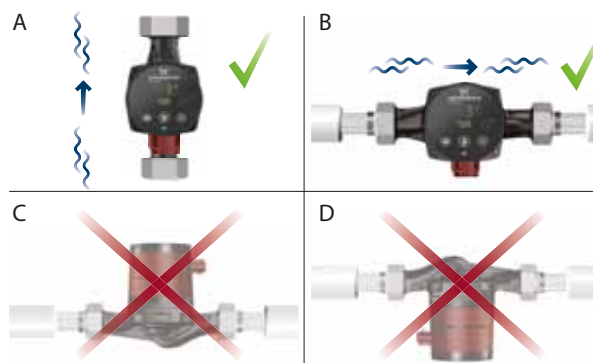

Fig. 2 Control box positions

Always install the pump with a horizontal motor shaft.

- Pump installed correctly in a vertical pipe. See fig. 2 (A).
- Pump installed correctly in a horizontal pipe. See fig. 2 (B).
- Do not install the pump with a vertical motor shaft. See fig. 2 (C and D).

TM07 4605 2119

3.3 Control box positions

3.3.1 Positioning of the control box in heating and domestic hot-water systems

You can position the control box in position 3, 6 and 9 o'clock. See fig. 3.

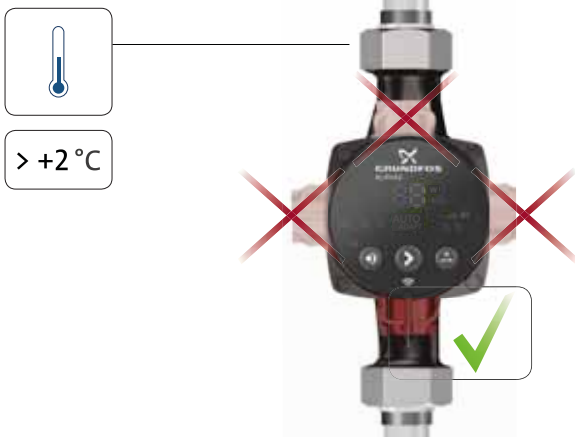

Fig. 3 Control box positions, heating and domestic hot-water systems

TM07 4606 2119

3.3.2 Positioning the control box in air-conditioning and cold-water systems

Position the control box with the plug pointing downwards. See fig. 4.



TM07 4607 2119

Fig. 4 Control box position, air-conditioning and cold-water systems

3.3.3 Changing the control box position

WARNING

Pressurised system

Death or serious personal injury
 - Tighten the bolts before opening the isolating valves. The pumped liquid may be scalding hot and under high pressure.



If you change the position of the control box, fill the system with the liquid to be pumped or open the isolating valves.

You can turn the control box in steps of 90 °.

1. Remove the four screws.
2. Turn the pump head to the desired position.
3. Insert and cross-tighten the screws.

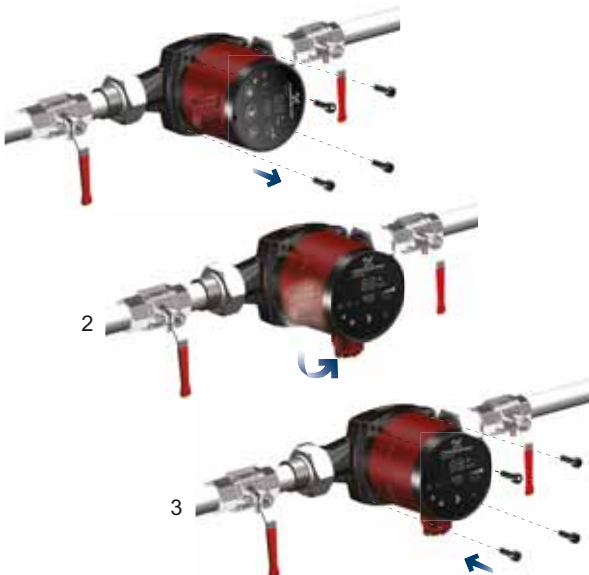

TM07 4608 2119

Fig. 5 Changing the control box position

3.4 Insulating the pump housing



TM07 4604 2119

Fig. 6 Insulating the pump housing

You can reduce the heat loss from the pump by insulating the pump housing with the insulating shells supplied with the pump. See fig. 6.



Do not insulate the control box or cover the operating panel.

3.5 Electrical installation

WARNING
Electric shock
 Death or serious personal injury
 - Switch off the power supply before starting any work on the product. Make sure that the power supply cannot be accidentally switched on.

WARNING
Electric shock
 Death or serious personal injury
 - Connect the pump to earth.

WARNING
Electric shock
 Death or serious personal injury
 - If national legislation requires a Residual Current Device (RCD) or equivalent in the electrical installation, or if the pump is connected to an electric installation where an RCD is used as an additional protection, this must be type A or better, due to the nature of the pulsating DC leakage current. The RCD must be marked with the symbol shown below;



WARNING
Electric shock
 Death or serious personal injury
 - All electrical connections must be carried out by a qualified electrician in accordance with local regulations.

- The pump requires no external motor protection.
- Check that the supply voltage and frequency correspond to the values stated on the nameplate. See section [5.4.2 Nameplate](#).
- Connect the pump to the power supply with the plug supplied with the pump. See steps 1 to 7.

3.6 Assembling the plug

Step	Action	Illustration
1	Fit the cable gland and plug cover to the cable. Strip the cable conductors as illustrated.	
2	Connect the cable conductors to the power supply plug.	

Step	Action	Illustration
3	Bend the cable with the cable conductors pointing upwards.	
4	Pull out the conductor guide plate and throw it away.	
5	Click the plug cover onto the power supply plug.	
6	Screw the cable gland onto the power supply plug.	
7	Insert the power supply plug into the male plug in the pump control box.	

4. Starting up the product

WARNING

Pressurised system

Death or serious personal injury

- Tighten the bolts before opening the isolating valves. The pumped liquid may be scalding hot and under high pressure.



4.1 Before startup

Do not start the pump until the system has been filled with liquid and vented. Make sure that the required minimum inlet pressure is available at the pump inlet. See section [10. Technical data](#). For instructions on how to vent the system, see section [4.3 Venting the pump](#).

4.2 First startup

After installing the product, turn on the power supply. The light in the operating panel shows that the power supply has been switched on. See fig. 7.

The pump is factory set to AUTO_{ADAPT}.



Fig. 7 Starting up the pump

4.3 Venting the pump



Fig. 8 Venting the pump

The pump is self-venting through the system. You do not have to vent the pump before startup.

Air in the pump may cause noise. This noise ceases when the pump has run for a few minutes.

You obtain quick venting of the pump by setting the pump to speed III. How fast the pump is vented depends on the system size and design.

When you have vented the pump, that is when the noise has ceased, set the pump according to the recommendations. See section [6. Control modes](#).



The pump must not run dry.

You cannot vent the system through the pump. See section [5. Product introduction](#).

TM07 4603 2119

TM07 462 21191

5. Product introduction

5.1 Product description

The pump is designed for circulating liquids in systems with variable flow rates where it is desirable to optimise the setting of the pump duty point to reduce energy costs.

The table below shows the ALPHA2 models with built-in functions and features.

Comparison of ALPHA2 models according to built-in functions and features

Functions/features	ALPHA2 model B	ALPHA2 model C	ALPHA2 model D	ALPHA2 model E
Starts from	PC 12xx*	PC 14xx*	PC 15xx*	PC 17xx*
AUTO _{ADAPT}	•	•	•	•
Proportional pressure	•	•	•	•
Constant pressure	•	•	•	•
Constant curve	•	•	•	•
Automatic night setback	•	•	•	•
Manual summer mode		•	•	•
Dry-running protection			•	•
ALPHA Reader compatible				•
High-torque start			•	•
ALPHA2XX-40	•	•	•	•
ALPHA2XX-50	•	•	•	•
ALPHA2XX-60	•	•	•	•
ALPHA2XX-80		•	•	•

* Production code (Year-Week).

5.2 Intended use

The pump is designed for circulating liquids in heating and air-conditioning systems with temperatures equal to or higher than 2 °C. You can also use pumps with stainless-steel pump housing in domestic hot-water systems.

5.3 Pumped liquids

The pump is suitable for the following liquids:

- clean, thin, non-aggressive and non-explosive liquids, not containing solid particles or fibres
- cooling liquids, not containing mineral oil
- softened water.

The kinematic viscosity of water is 1 mm²/s (1 cSt) at 20 °C. If the pump is used for a liquid with a higher viscosity, the hydraulic performance of the pump will be reduced.

Example: 50 % glycol at 20 °C means a viscosity of approx. 10 mm²/s (10 cSt) and a reduction of the pump performance by approx. 15 %.

Do not use additives that can or will disturb the functionality of the pump.

When selecting a pump, take the viscosity of the pumped liquid into consideration.

For more information about the pumped liquids, warnings and operating conditions, see section [Comparison of ALPHA2 models according to built-in functions and features](#).

5.4 Identification

5.4.1 Model type

These installation and operating instructions cover ALPHA2 model B, C, D and E. The model type is stated on the packaging and nameplate. See figs 9 and 10.



Fig. 9 Model type on the packaging



Fig. 10 Model type on the nameplate

5.4.2 Nameplate

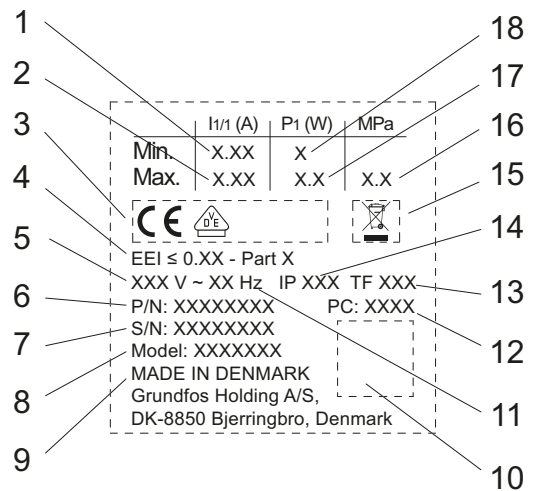

Fig. 11 Nameplate

Pos.	Description
1	Minimum rated current [A]
2	Maximum rated current [A]
3	CE mark and approvals
4	EEL: Energy Efficiency Index
5	Voltage [V]
6	Product number
7	Serial number
8	Pump model
9	Country of origin
10	Data matrix code
11	Frequency [Hz]
12	Production code: • 1st and 2nd figures: year • 3rd and 4th figures: week
13	Temperature class
14	Enclosure class
15	Crossed-out wheeled bin according to EN 50419
16	Maximum system pressure [MPa]
17	Minimum input power P1 [W]
18	Maximum input power P1 [W]

5.4.3 Type key

Example	ALPHA2	25	-40	N	180
Pump type []: Standard version					
Nominal diameter (DN) of inlet and outlet ports [mm]					
Maximum head [dm]					
[]: Cast-iron pump housing					
A: Pump housing with air separator					
N: Stainless-steel pump housing					
Port-to-port length [mm]					











TM06 45820 2515

TM06 1716 2614

TM05 3079 0912

5.5 Accessories

5.5.1 Unions and valve kits

		Product numbers, unions													
ALPHA2	Connection	Union nut with internal threads			Union nut with external threads		Ball valve with internal threads			Ball valve with compression fitting		Union nut with soldering fitting			
															
15-xx*	G 1	3/4	1	1 1/4	1	1 1/4	3/4	1	1 1/4	Ø22	Ø28	Ø18	Ø22	Ø28	Ø42
15-xx N*															
25-xx	G 1 1/2	529921	529922	529821	529925	529924									
25-xx N		529971	529972				519805	519806	519807	519808	519809	529977	529978	529979	
32-xx	G 2		509921	509922											
32-xx N				509971											

Note: The product numbers are always for one complete set, including gaskets.

G-threads have a cylindrical form in accordance with the EN ISO 228-1 standard and are not sealing the thread. It requires a flat gasket. You can only screw male G-threads (cylindrical) into female G-threads. The G-threads are standard thread on the pump housing.

R-threads are tapered external threads in accordance with the EN 10226-1 standard.

Rc- or Rp-threads are internal threads with either tapered or cylindrical (parallel) threads. You can screw male R-threads (conical) into female Rc- or Rp-threads. See fig. 12.

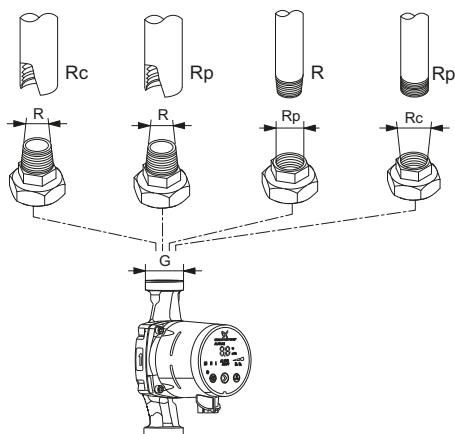

TM06 9235 2017

Fig. 12 G-threads and R-threads

5.6 Insulating shells, ALPHA2

The pump is supplied with two insulating shells. Type A pumps with air-separating chamber are not supplied with insulating shells. However, you can order insulating shells as an accessory. See table below.

The insulation thickness of the insulating shells corresponds to the nominal diameter of the pump.

The insulating shells, which are tailored to the individual pump type, enclose the entire pump housing. The insulating shells are easy to fit around the pump. See fig. 13.

Pump type	Product number
ALPHA2 XX-XX 130	98091786
ALPHA2 XX-XX 180	98091787



Fig. 13 Insulating shells

5.7 ALPHA plugs

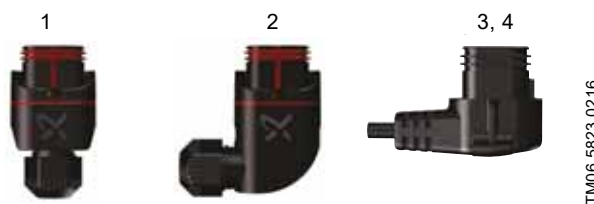

Fig. 14 ALPHA plugs

Pos.	Description	Product number
1	ALPHA straight plug, standard plug connector, complete	98284561
2	ALPHA angle plug, standard angle plug connection, complete	98610291
3	ALPHA plug, 90 ° bend to the left, including 4 m cable	96884669
4	ALPHA plug, 90 ° bend to the left, including 1 m cable and integrated NTC protection resistor*	97844632

* This special cable with an active built-in NTC protection circuit reduces possible inrush currents. To be used in case of for instance poor quality of relay components that are sensitive to inrush current.

5.8 ALPHA Reader



The ALPHA Reader is the receiver and transmitter of pump real time performance data.

The unit uses a CR2032 lithium battery.

The unit is together with the Grundfos GO Balance app used for balancing heating systems primarily in one- and two-family houses. The app is available for both Android and iOS devices, and you can download it free of charge from Google Play and App Store.

Description	Product number
ALPHA Reader MI401	98916967

For further information, see section [7.9 Using ALPHA Reader](#).

TM06 8574 1517

TM07 4604 2119

TM06 5823 0216

6. Control modes

6.1 AUTO_{ADAPT}

In AUTO_{ADAPT} mode, the pump is set to proportional-pressure control. AUTO_{ADAPT} is recommended for two-pipe heating systems. See section 6.6 *Guide to control mode selection*.

AUTO_{ADAPT} selects the best control curve under the given operating conditions, meaning that the pump performance is automatically adjusted to the actual heat demand, that is the size of the system and the changing heat demand over time, by continuously selecting a proportional-pressure curve.

You cannot expect an optimum pump setting from day one. If the power supply fails or is disconnected, the pump stores the AUTO_{ADAPT} setting in an internal memory and resumes the automatic adjustment when the power supply has been restored.



The pump is factory set to AUTO_{ADAPT}.

6.2 Proportional-pressure mode

Proportional-pressure control adjusts the pump performance to the actual heat demand in the system, but the pump performance follows the selected performance curve, PP1, PP2 or PP3. See fig. 15 where PP2 has been selected. The selection of the proportional-pressure setting depends on the characteristics of the heating system and the actual heat demand.

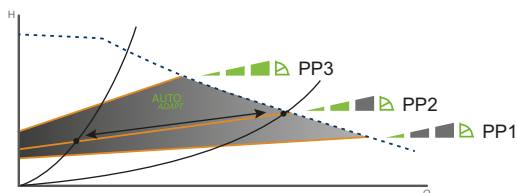

Fig. 15 Three proportional-pressure curves

6.3 Constant-pressure mode

The constant-pressure control adjusts the flow rate to the actual heat demand in the system keeping a constant pressure at the same time. The pump performance follows the selected performance curve, CP1, CP2 or CP3. See fig. 16 where CP1 has been selected. The selection of the constant-pressure setting depends on the characteristics of the heating system and the actual heat demand.

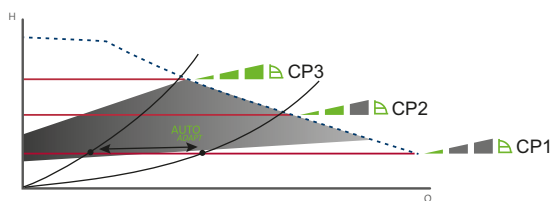

Fig. 16 Three constant-pressure curves

6.4 Constant curve/constant speed

At constant-curve/constant-speed operation, the pump runs at a constant speed, independently of the actual flow rate demand in the system. The pump performance follows the selected performance curve, I, II or III. See fig. 17 where II has been selected. The selection of the constant-curve/constant-speed setting depends on the characteristics of the heating system and the number of taps likely to be opened at the same time.

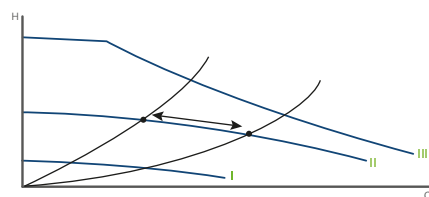

Fig. 17 Three constant curve/constant speed settings

6.5 Automatic night setback

With automatic night setback enabled the pump automatically changes between normal operation and the automatic night setback curve.

The pump changes to automatic night setback when a flow-pipe temperature drop of more than 10 to 15 °C within approximately two hours is registered. The temperature drop must be at least 0.1 °C/min.

Changeover to normal operation takes place without a time lag when the flow-pipe temperature has increased by approximately 10 °C. You do not have to re-enable automatic night setback if the power supply has been switched off.

If the power supply is switched off when the pump is running on the curve for automatic night setback, the pump starts in normal operation. The pump changes back to the curve for automatic night setback when the condition for automatic night setback is fulfilled again.

If there is insufficient heat in the heating system, check whether automatic night setback has been enabled. If yes, disable the function.

6.6 Guide to control mode selection

System type	Pump setting	
	Recommended	Alternative
Two-pipe heating system	AUTO _{ADAPT}	Proportional-pressure curve, PP1, PP2 or PP3
One-pipe heating system	Constant curve/constant speed, I, II or III	Constant-pressure curve CP1, CP2 or CP3
Underfloor heating system	Constant-pressure curve, CP1, CP2 or CP3	Constant curve/constant speed, I, II or III
Domestic hot water system	Constant curve/constant speed, I, II or III	Constant-pressure curve, CP1, CP2 or CP3

6.6.1 Changing from recommended to alternative pump setting

Heating systems are relatively slow systems that cannot be set to the optimum operation within minutes or hours.

If the recommended pump setting does not give the desired distribution of heat in the rooms of the house, change the pump setting to the shown alternative.

TM05 3064 0912

TM05 3066 0912

TM05 3068 0912

6.7 Pump performance

If the recommended pump setting does not give the desired distribution of heat in the rooms of the house, change the pump setting to the shown alternative.

Relation between pump setting and pump performance.

Figure 18 shows the relation between pump setting and pump performance by means of curves. See also section 11. [Performance curves](#).

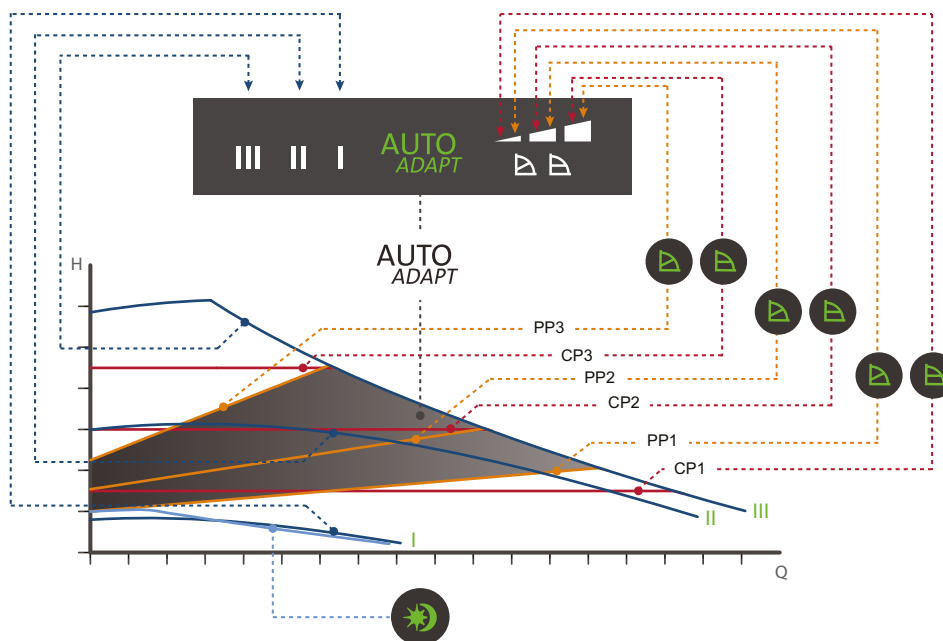

TM05 2771 2817

Fig. 18 Pump setting in relation to pump performance

Setting	Pump curve	Function
AUTO _{ADAPT} factory setting	Highest to lowest proportional-pressure curve	The AUTO _{ADAPT} function enables the pump to control the pump performance automatically within a defined performance range. See fig. 18. <ul style="list-style-type: none"> Adjusting the pump performance to the size of the system. Adjusting the pump performance to the variations in load over time. In AUTO _{ADAPT} , the pump is set to proportional-pressure control.
PP1	Lowest proportional-pressure curve	The duty point of the pump will move up or down on the lowest proportional-pressure curve, depending on the heat demand. See fig. 18. The head is reduced at falling heat demand and increased at rising heat demand.
PP2	Intermediate proportional-pressure curve	The duty point of the pump will move up or down on the intermediate proportional-pressure curve, depending on the heat demand. See fig. 18. The head is reduced at falling heat demand and increased at rising heat demand.
PP3	Highest proportional-pressure curve	The duty point of the pump will move up or down on the highest proportional-pressure curve, depending on the heat demand. See fig. 18. The head is reduced at falling heat demand and increased at rising heat demand.
CP1	Lowest constant-pressure curve	The duty point of the pump will move out or in on the lowest constant-pressure curve, depending on the heat demand in the system. See fig. 18. The head is kept constant, irrespective of the heat demand.
CP2	Intermediate constant-pressure curve	The duty point of the pump will move out or in on the intermediate constant-pressure curve, depending on the heat demand in the system. See fig. 18. The head is kept constant, irrespective of the heat demand.
CP3	Highest constant-pressure curve	The duty point of the pump will move out or in on the highest constant-pressure curve, depending on the heat demand in the system. See fig. 18. The head is kept constant, irrespective of the heat demand.
III	Speed III	The pump runs on a constant curve which means that it runs at a constant speed. In speed III, the pump is set to run on the maximum curve under all operating conditions. See fig. 18. You obtain quick venting of the pump by setting the pump to speed III for a short period. See section 4.3 Venting the pump .
II	Speed II	The pump runs on a constant curve which means that it runs at a constant speed. In speed II, the pump is set to run on the intermediate curve under all operating conditions. See fig. 18.
I	Speed I	The pump runs on a constant curve which means that it runs at a constant speed. In speed I, the pump is set to run on the minimum curve under all operating conditions. See fig. 18.
	Automatic night setback or manual summer mode	The pump changes to the curve for automatic night setback, provided that certain conditions are met.

7. Setting the product

WARNING

Hot surface



Death or serious personal injury

- The pump housing may be hot due to the pumped liquid being scalding hot. Touch only the operating panel.

7.1 Elements on the operating panel



Fig. 19 Operating panel

Pos.	Description
1	Display showing the actual power consumption in watt or the actual flow rate in m ³ /h.
2	Light fields indicating the pump setting. See section 7.3 <i>Light fields indicating the pump setting</i> .
3	Light field indicating the status of automatic night setback and manual summer mode.
4	Button for enabling or disabling of automatic night setback and manual summer mode.
5	Button for selection of pump setting.
6	Button for selection of parameter to be shown in the display, i.e. actual power consumption in watt or actual flow rate in m ³ /h. The button is also used to activate the ALPHA Reader mode on the pump. See section 7.9.1 <i>Activating and deactivating the ALPHA Reader mode on the pump</i> .
7	Connectivity symbol.

7.2 Display

The display (1) is on when you have switched on the power supply.

The display shows the actual pump power consumption in watt or the actual flow rate in m³/h in steps of 0.1 m³/h during operation.

Faults preventing the pump from operating properly, for example a blocked rotor, are indicated in the display by fault codes. See section 9. *Fault finding the product*.

If a fault is indicated, correct the fault and reset the pump by switching the power supply off and on.

7.3 Light fields indicating the pump setting

If the pump impeller is rotated, for example when filling the pump with water, sufficient energy can be generated to light up the display even if the power supply has been switched off.

The pump has ten performance settings which you can select with the button (5). See fig. 19.

The pump setting is indicated by nine light fields in the display. See fig. 20.



Fig. 20 Nine light fields

Button presses	Active light fields	Description
0	Factory setting AUTO ADAPT	AUTO _{ADAPT}
1		Lowest proportional-pressure curve, PP1
2		Intermediate proportional-pressure curve, PP2
3		Highest proportional-pressure curve, PP3
4		Lowest constant-pressure curve, CP1
5		Intermediate constant-pressure curve, CP2
6		Highest constant-pressure curve, CP3
7		Constant curve
8		Constant curve
9		Constant curve

For information about the function of the settings, see section 6. *Control modes*.



TM05 3061 0912

TM07 4600 2119

7.4 Button for enabling or disabling of automatic night setback

The button enables and disables automatic night setback. See fig. 19 (4).

Automatic night setback is only relevant for heating systems prepared for this function. See section 9. [Fault finding the product](#).

The light field  is on  when automatic night setback is active. See fig. 19 (3).

Factory setting: automatic night setback is not active.

If you have set the pump to speed I, II or III, you cannot select automatic night setback.

7.5 Button for selection of pump setting

Every time you press the button , the pump setting is changed. See fig. 19 (5).

A cycle is ten button presses. See section 7.3 [Light fields indicating the pump setting](#)

7.6 Setting automatic night setback

If you select speed I, II or III, automatic night setback is disabled. You do not have to re-enable automatic night setback if the power supply has been switched off.

If the power supply is switched off when the pump is running on the curve for automatic night setback, the pump starts in normal operation. See section 9. [Fault finding the product](#).

The pump changes back to the curve for automatic night setback when the condition for automatic night setback is fulfilled again. See section 7.7 [Setting manual summer mode](#).

If there is insufficient heat in the heating system, check whether automatic night setback has been enabled. If yes, disable the function.

To ensure the optimum function of automatic night setback, the following conditions must be fulfilled:

- The pump must be installed in the flow pipe. See fig. 21.
- The boiler must incorporate automatic control of the liquid temperature.



Do not use automatic night setback when the pump is installed in the return pipe of the heating system.



Fig. 21 Automatic night setback conditions

Enable automatic night setback by pressing . See section 7.4 [Button for enabling or disabling of automatic night setback](#).

Light in  means that automatic night setback is active.

7.7 Setting manual summer mode

Manual summer mode is available as from ALPHA2 model C.

In manual summer mode, the pump is stopped to save energy. To avoid lime precipitation and blocking of the pump, the pump is started frequently in a short period. This is an alternative to shutting down the pump if there is a risk of lime deposit.



There is a risk of lime deposit in case of a long standstill period.

In manual summer mode, the pump starts frequently at low speed to avoid blocking the rotor. The display is turned off.

If any alarms occur during manual summer mode, no alarms will be shown. When manual summer mode is deactivated again, only the actual alarms will be displayed.

If the automatic night setback mode is enabled before setting the manual summer mode, the pump will return to automatic night setback mode after manual summer mode.

7.7.1 Activating manual summer mode

Activate the manual summer mode by pressing the automatic night setback button 3 to 10 seconds. See fig. 23. The green light field flashes quickly. After a short while the display turns off and the green light field  flashes slowly.



Fig. 22 Automatic night setback button

7.7.2 Deactivating manual summer mode

Deactivate the manual summer mode by pressing any of the buttons. Then the pump returns to the previous mode and setting.

7.8 Dry-running protection

The dry-running protection protects the pump against dry running during start and normal operation. See section 9. [Fault finding the product](#).

During first startup and in case of dry running, the pump will operate for 30 minutes before stopping. During this period the pump displays the error code "E4 - - -".

Dry-running protection is available as from ALPHA2 model D.

7.9 Using ALPHA Reader



TM06 4452 2315

Fig. 23 ALPHA Reader



The ALPHA Reader is compatible as from ALPHA2 model E. A connectivity symbol on the pump indicates compatibility with the ALPHA Reader. See fig. 23.

The ALPHA Reader provides safe readout of internal data from the pump to an Android or iOS-based device via Bluetooth.

The unit is together with the Grundfos GO Balance app used for balancing heating systems primarily in one- and two-family houses. The app guides you through a number of steps where information on installation and measurements from the pump is being collected. In a two-pipe radiator heating system or an underfloor heating system, the app calculates the balancing values for each of the valves. On the basis of these values, the app guides you through the adjustment of each presetting valve in the system.

For further information on how to set the ALPHA Reader and perform hydronic balancing, see the ALPHA Reader documentation in Grundfos Product Center on www.grundfos.com.

7.9.1 Activating and deactivating the ALPHA Reader mode on the pump

1. Press [W/m³/h]  and hold it for 3 seconds.
2. ALPHA Reader is either activated or deactivated, depending on the previous state. When ALPHA Reader is active, the unit indicator in the display [W/m³/h] flashes rapidly.



You can activate and deactivate the ALPHA Reader mode in all pump modes.

See separate installation and operating instructions for further information on how to use the ALPHA Reader.

See also section [5.8 ALPHA Reader](#).

8. Servicing the product

WARNING

Electric shock



- Death or serious personal injury
- Switch off the power supply before starting any work on the product. Make sure that the power supply cannot be accidentally switched on.

DANGER

Pressurised system



- Minor or moderate personal injury
- Before dismantling the pump, drain the system or close the isolating valves on both sides of the pump. Slowly loosen the screws and unpressurise the system. The pumped liquid may be scalding hot and under high pressure.

WARNING

Hot surface



- Minor or moderate personal injury
- The pump housing may be hot due to the pumped liquid being scalding hot. Close the isolating valves on both sides of the pump and wait for the pump housing to cool down.

WARNING

Hot liquid



- Death or serious personal injury
- Before dismantling the pump, drain the system or close the isolating valves on both sides of the pump. Slowly loosen the screws and unpressurise the system. The pumped liquid may be scalding hot and under high pressure.

CAUTION

Crushing of feet



- Minor or moderate personal injury
- Wear safety shoes when handling the product.

CAUTION

Sharp element







- Minor or moderate personal injury
- Use protective gloves when servicing the product.

8.1 Dismantling the product

1. Switch off the power supply.
2. Pull out the plug. For instructions on how to dismantle the plug, see section [8.2 Dismantling the plug](#).
3. Close the two isolating valves on both sides of the pump.
4. Loosen the fittings.
5. Remove the pump from the system.

8.2 Dismantling the plug

Step	Action	Illustration
1	Loosen the cable gland and remove it from the plug.	
2	Pull off the plug cover while pressing on both sides.	
3	Add the conductor guide plate to loosen all three cable conductors at the same time. If the guide plate is missing, then loosen the cable conductors one by one by pressing a screwdriver gently into the terminal clip.	
4	The plug has now been removed from the power supply plug.	

TM05 5545 3812

TM05 5546 3812

TM05 5547 3812

TM05 5548 3812

9. Fault finding the product

DANGER

Electric shock



- Death or serious personal injury
- Switch off the power supply before starting any work on the product. Make sure that the power supply cannot be accidentally switched on.

CAUTION

Pressurised system



- Minor or moderate personal injury
- Before dismantling the pump, drain the system or close the isolating valves on either side of the pump. The pumped liquid may be scalding hot and under high pressure.

WARNING

Electric shock



- Death or serious personal injury
- A damaged product must be repaired by Grundfos or a service workshop authorised by Grundfos.

WARNING

Hot surface



- Minor or moderate personal injury
- The pump housing may be hot due to the pumped liquid being scalding hot. Close the isolating valves on both sides of the pump and wait for the pump housing to cool down.

9.1 High-torque start

If the shaft is blocked and you cannot start the pump, the display indicates the alarm "E1 - " - """, with a delay of 30 minutes.

The pump attempts to restart until the pump is powered off.

During the start attempts, the pump vibrates due to the high-torque load.

High-torque start is available as from ALPHA2 model D.

9.2 Fault finding table

Fault	Operating panel	Cause	Remedy	
1. The pump does not run.	Light off.	a) A fuse in the installation is blown.	Replace the fuse.	
		b) The current-operated or voltage-operated circuit breaker has tripped.	Cut in the circuit breaker.	
		c) The pump is defective.	Replace the pump.	
		Changes between "- -" and "E 1".	a) The rotor is blocked.	Remove the impurities.
		Changes between "- -" and "E 2".	a) Insufficient supply voltage.	Make sure that the supply voltage falls within the specified range.
Changes between "- -" and "E 3".	a) Electrical fault.	Replace the pump.		
		Changes between "- -" and "E 4".	a) Dry-running protection.	Make sure that there is sufficient liquid in the pipe system. Reset the warning by pressing any button or switch off the power supply.
2. Noise in the system.	No warning is indicated on the display.	a) Air in the system.	Vent the system. See section 4.3 Venting the pump .	
		b) The flow rate is too high.	Reduce the suction head.	
3. Noise in the pump.	No warning is indicated on the display.	a) Air in the pump.	Let the pump run. The pump vents itself over time.	
		b) The inlet pressure is too low.	Increase the inlet pressure, or make sure that the air volume in the expansion tank is sufficient, if installed.	
4. Insufficient heat.	No warning is indicated on the display.	a) The pump performance is too low.	Change the pump setting to increase the pump performance. See section 6.6.1 Changing from recommended to alternative pump setting .	

10. Technical data

Operating conditions		
Relative humidity	Maximum 95 % RH	
System pressure	Maximum 1.0 MPa, 10 bar, 102 m head	
Inlet pressure	Liquid temperature	Minimum inlet pressure
	≤ 75 °C	0.005 MPa, 0.05 bar, 0.5 m head
	90 °C	0.028 MPa, 0.28 bar, 2.8 m head
	110 °C	0.108 MPa, 1.08 bar, 10.8 m head
Sound pressure level	The sound pressure level of the pump is lower than 43 dB(A).	
Ambient temperature	0-40 °C	
Surface temperature	The maximum surface temperature will not exceed 125 °C.	
Liquid temperature	2-110 °C	
Electrical data		
Supply voltage	1 x 230 V ± 10 %, 50/60 Hz, PE	
Insulation class	F	
Power consumption in manual summer mode	< 0.8 watt	
Miscellaneous data		
Motor protection	The pump requires no external motor protection.	
Temperature class	TF110 to EN 60335-2-51	
Enclosure class	IPX4D	
Specific EEI values	ALPHA2 XX-40: EEI ≤ 0.15	
	ALPHA2 XX-50: EEI ≤ 0.16	
	ALPHA2 XX-60: EEI ≤ 0.17	
	ALPHA2 XX-80: EEI ≤ 0.18	

To avoid condensation in the control box and stator, the liquid temperature must always be higher than the ambient temperature.

Ambient temperature [°C]	Minimum liquid temperature [°C]
0	2
10	10
20	20
30	30
35	35
40	40



The pump can run at ambient temperatures slightly higher than the liquid temperature if the plug connection in the pump head is pointing downwards.

10.1 Dimensions, ALPHA2 XX-40, XX-50, XX-60, XX-80

Dimensional sketches and table of dimensions.

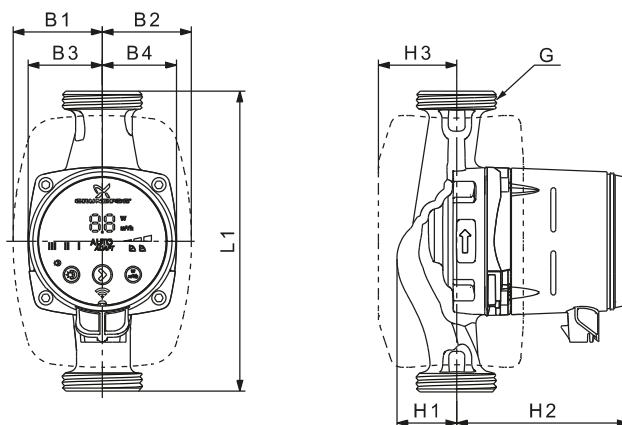

TM05 2364 5011

Pump type	Dimensions								
	L1	B1	B2	B3	B4	H1	H2	H3	G
ALPHA2 15-40 130	130	54	54	44	44	36	104	47	G 1
ALPHA2 15-50 130	130	54	54	44	44	36	104	47	G 1*
ALPHA2 15-60 130	130	54	54	44	44	36	104	47	G 1*
ALPHA2 15-80 130	130	54	54	44	44	36	104	47	G 1
ALPHA2 25-40 130	130	54	54	44	44	36	104	47	G 1 1/2
ALPHA2 25-40 N 130	130	54	54	44	44	37	104	47	G 1 1/2
ALPHA2 25-50 130	130	54	54	44	44	36	104	47	G 1 1/2
ALPHA2 25-50 N 130	130	54	54	44	44	37	104	47	G 1 1/2
ALPHA2 25-60 130	130	54	54	44	44	36	104	47	G 1 1/2
ALPHA2 25-60 N 130	130	54	54	44	44	37	104	47	G 1 1/2
ALPHA2 25-80 130	130	54	54	44	44	36	104	47	G 1 1/2
ALPHA2 25-80 N 130	130	54	54	44	44	37	104	47	G 1 1/2
ALPHA2 25-40 180	180	54	54	44	44	36	104	47	G 1 1/2
ALPHA2 25-40 N 180	180	54	54	44	44	37	104	47	G 1 1/2
ALPHA2 25-50 180	180	54	54	44	44	36	104	47	G 1 1/2
ALPHA2 25-50 N 180	180	54	54	44	44	37	104	47	G 1 1/2
ALPHA2 25-60 180	180	54	54	44	44	36	104	47	G 1 1/2
ALPHA2 25-60 N 180	180	54	54	44	44	3	104	47	G 1 1/2
ALPHA2 25-80 180	180	54	54	44	44	36	104	47	G 1 1/2
ALPHA2 25-80 N 180	180	54	54	44	44	37	104	47	G 1 1/2
ALPHA2 32-40 180	180	54	54	44	44	36	104	47	G 2
ALPHA2 32-40 N 180	180	54	54	44	44	37	104	47	G 2
ALPHA2 32-50 180	180	54	54	44	44	36	104	47	G 2
ALPHA2 32-50 N 180	180	54	54	44	44	37	104	47	G 2
ALPHA2 32-60 180	180	54	54	44	44	36	104	47	G 2
ALPHA2 32-60 N 180	180	54	54	44	44	37	104	47	G 2
ALPHA2 32-80 180	180	54	54	44	44	36	104	47	G 2
ALPHA2 32-80 N 180	180	54	54	44	44	37	104	47	G 2

11. Performance curves

11.1 Guide to performance curves

Each pump setting has its own performance curve. However, AUTO_{ADAPT} covers a performance range.

A power curve, P1, belongs to each performance curve. The power curve shows the pump power consumption in watt at a given performance curve.

11.2 Curve conditions

The guidelines below apply to the performance curves on the following pages:

- Test liquid: airless water.
- The curves apply to a density of $\rho = 983.2 \text{ kg/m}^3$ and a liquid temperature of 60 °C.
- All curves show average values and must not be used as guarantee curves. If a specific minimum performance is required, individual measurements must be made.
- The curves for speeds I, II and III are marked.
- The curves apply to a kinematic viscosity of $\nu = 0.474 \text{ mm}^2/\text{s}$ (0.474 cSt).
- The conversion between head H [m] and pressure p [kPa] has been made for water with a density of 1000 kg/m³. For liquids with other densities, for example hot water, the outlet pressure is proportional to the density.
- Curves are obtained according to EN 16297-2.

11.3 Performance curves, ALPHA2 XX-40 (N)

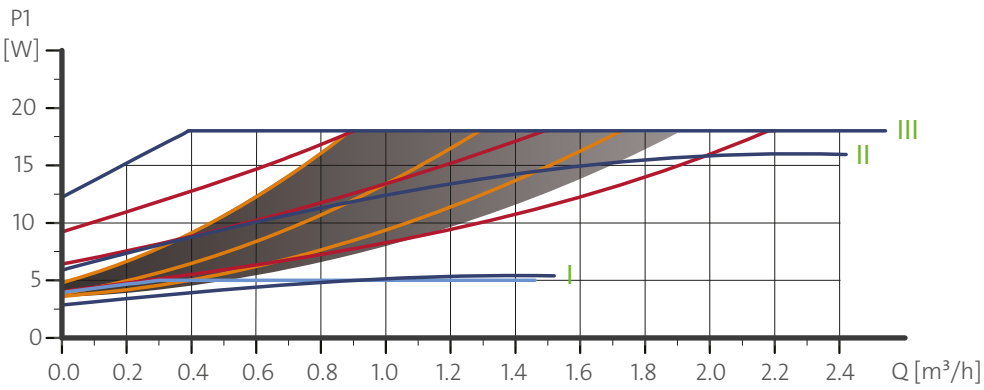
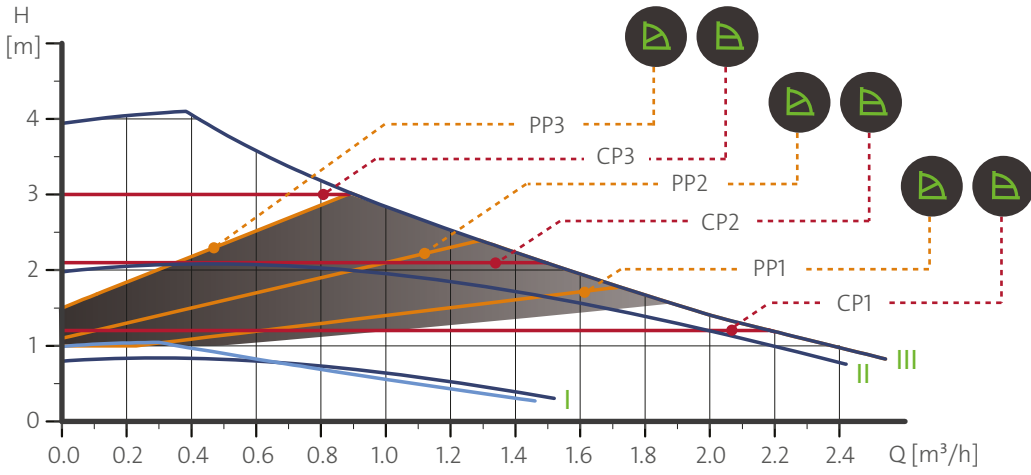

Setting	P1 [W]	I _{1/1} [A]
AUTO _{ADAPT}	3-18	0.04 - 0.18
Min.	3	0.04
Max.	18	0.18

TM05 1672 4111

11.4 Performance curves, ALPHA2 XX-50 (N)

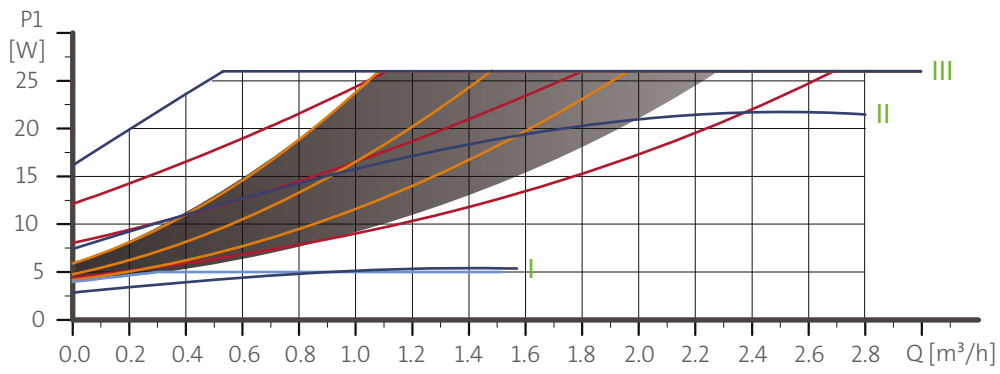
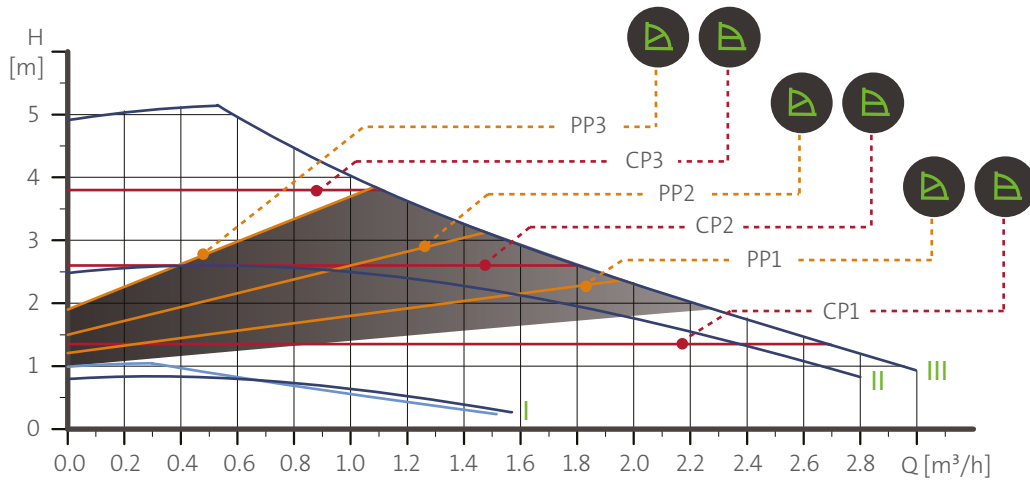

Setting	P1 [W]	I _{1/1} [A]
AUTO _{ADAPT}	3-26	0.04 - 0.24
Min.	3	0.04
Max.	26	0.24

11.5 Performance curves, ALPHA2 XX-60 (N)

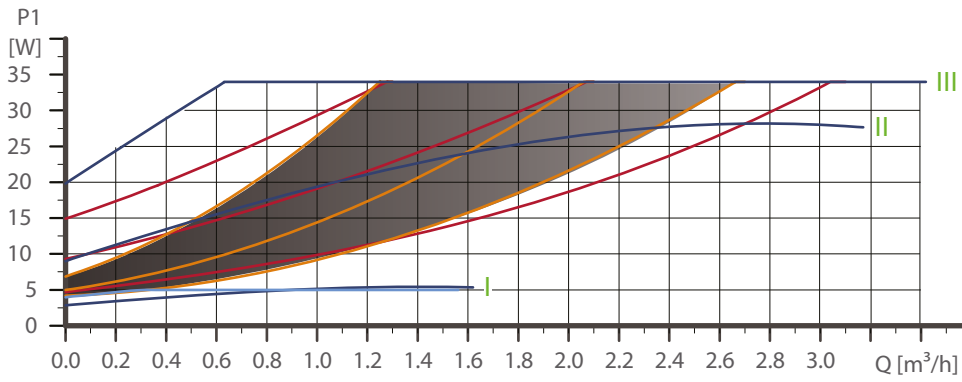
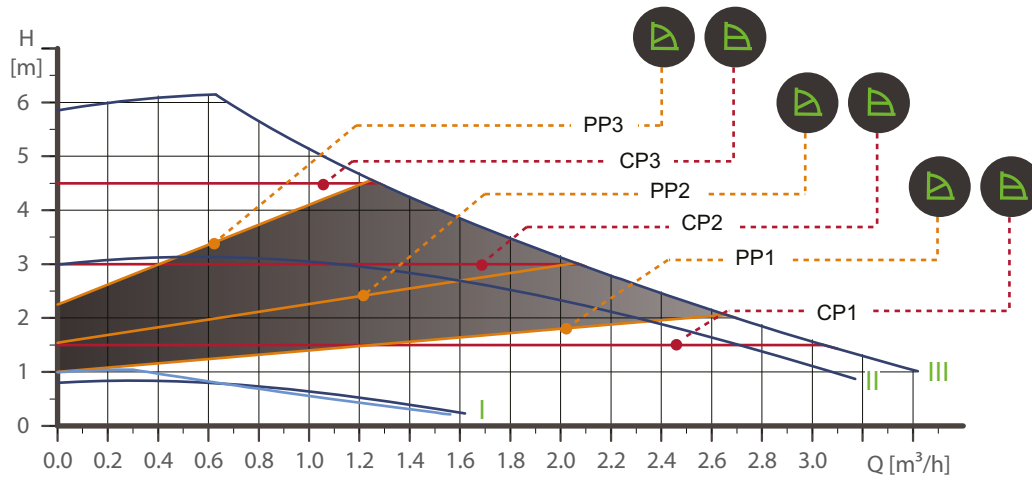

Setting	P1 [W]	I _{1/1} [A]
AUTO _{ADAPT}	3-34	0.04 - 0.32
Min.	3	0.04
Max.	34	0.32

TM05 1674 4111

11.6 Performance curves, ALPHA2 XX-80 (N)

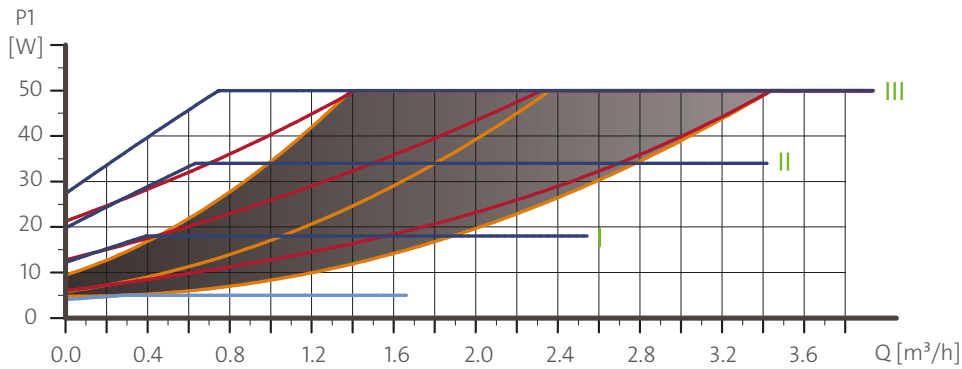
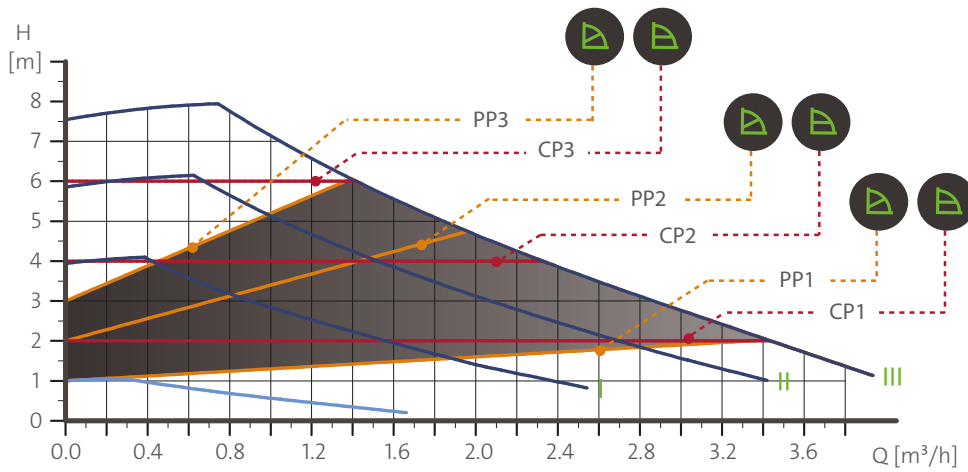

Setting	P1 [W]	I _{1/1} [A]
AUTO _{ADAPT}	3-50	0.04 - 0.44
Min.	3	0.04
Max.	50	0.44

12. Disposing of the product

This product or parts of it must be disposed of in an environmentally sound way:

1. Use the public or private waste collection service.
2. If this is not possible, contact the nearest Grundfos company or service workshop.



The crossed-out wheellie bin symbol on a product means that it must be disposed of separately from household waste. When a product marked with this symbol reaches its end of life, take it to a collection point designated by the local waste disposal

authorities. The separate collection and recycling of such products will help protect the environment and human health.

See also end-of-life information at www.grundfos.com/product-recycling.

TM06 1285 2114

Argentina

Bombas GRUNDFOS de Argentina S.A.
Ruta Panamericana km. 37.500 Centro
Industrial Garin
1619 Garin Pcia. de B.A.
Phone: +54-3327 414 444
Telefax: +54-3327 45 3190

Australia

GRUNDFOS Pumps Pty. Ltd.
P.O. Box 2040
Regency Park
South Australia 5942
Phone: +61-8-8461-4611
Telefax: +61-8-8340 0155

Austria

GRUNDFOS Pumpen Vertrieb Ges.m.b.H.
Grundfosstraße 2
A-5082 Grödig/Salzburg
Tel.: +43-6246-883-0
Telefax: +43-6246-883-30

Belgium

N.V. GRUNDFOS Bellux S.A.
Boomssesteenweg 81-83
B-2630 Aartselaar
Tél.: +32-3-870 7300
Télécopie: +32-3-870 7301

Belarus

Представительство ГРУНДФОС в
Минске
220125, Минск
ул. Шафарнянская, 11, оф. 56, БЦ
«Порт»
Тел.: +7 (375 17) 286 39 72/73
Факс: +7 (375 17) 286 39 71
E-mail: minsk@grundfos.com

Bosnia and Herzegovina

GRUNDFOS Sarajevo
Zmaja od Bosne 7-7A,
BH-71000 Sarajevo
Phone: +387 33 592 480
Telefax: +387 33 590 465
www.ba.grundfos.com
e-mail: grundfos@bih.net.ba

Brazil

BOMBAS GRUNDFOS DO BRASIL
Av. Humberto de Alencar Castelo Branco,
630
CEP 09850 - 300
São Bernardo do Campo - SP
Phone: +55-11 4393 5533
Telefax: +55-11 4343 5015

Bulgaria

Grundfos Bulgaria EOOD
Slatina District
Iztochna Tangenta street no. 100
BG - 1592 Sofia
Tel. +359 2 49 22 200
Fax. +359 2 49 22 201
email: bulgaria@grundfos.bg

Canada

GRUNDFOS Canada Inc.
2941 Brighton Road
Oakville, Ontario
L6H 6C9
Phone: +1-905 829 9533
Telefax: +1-905 829 9512

China

GRUNDFOS Pumps (Shanghai) Co. Ltd.
10F The Hub, No. 33 Suhong Road
Minhang District
Shanghai 201106
PRC
Phone: +86 21 612 252 22
Telefax: +86 21 612 253 33

COLOMBIA

GRUNDFOS Colombia S.A.S.
Km 1.5 vía Siberia-Cota Conj. Potrero
Chico,
Parque Empresarial Arcos de Cota Bod.
1A.
Cota, Cundinamarca
Phone: +57(1)-2913444
Telefax: +57(1)-8764586

Croatia

GRUNDFOS CROATIA d.o.o.
Buzinski prilaz 38, Buzin
HR-10010 Zagreb
Phone: +385 1 6595 400
Telefax: +385 1 6595 499
www.hr.grundfos.com

GRUNDFOS Sales Czechia and**Slovakia s.r.o.**

Čajkovského 21
779 00 Olomouc
Phone: +420-585-716 111

Denmark

GRUNDFOS DK A/S
Martin Bachs Vej 3
DK-8850 Bjerringbro
Tlf.: +45-87 50 50 50
Telefax: +45-87 50 51 51
E-mail: info_GDK@grundfos.com
www.grundfos.com/DK

Estonia

GRUNDFOS Pumps Eesti OÜ
Peterburi tee 92G
11415 Tallinn
Tel: + 372 606 1690
Fax: + 372 606 1691

Finland

OY GRUNDFOS Pumpat AB
Trukkikuja 1
FI-01360 Vantaa
Phone: +358-(0) 207 889 500

France

Pompes GRUNDFOS Distribution S.A.
Parc d'Activités de Chesnes
57, rue de Malacombe
F-38290 St. Quentin Fallavier (Lyon)
Tél.: +33-4 74 82 15 15
Télécopie: +33-4 74 94 10 51

Germany

GRUNDFOS GMBH
Schlüterstr. 33
40699 Erkrath
Tel.: +49-(0) 211 929 69-0
Telefax: +49-(0) 211 929 69-3799
e-mail: infoservice@grundfos.de
Service in Deutschland:
e-mail: kundendienst@grundfos.de

Greece

GRUNDFOS Hellas A.E.B.E.
20th km. Athinon-Markopoulou Av.
P.O. Box 71
GR-19002 Peania
Phone: +0030-210-66 83 400
Telefax: +0030-210-66 46 273

Hong Kong

GRUNDFOS Pumps (Hong Kong) Ltd.
Unit 1, Ground floor
Siu Wai Industrial Centre
29-33 Wing Hong Street &
68 King Lam Street, Cheung Sha Wan
Kowloon
Phone: +852-27861706 / 27861741
Telefax: +852-27858664

Hungary

GRUNDFOS Hungária Kft.
Tópark u. 8
H-2045 Törökbálint,
Phone: +36-23 511 110
Telefax: +36-23 511 111

India

GRUNDFOS Pumps India Private Limited
118 Old Mahabalipuram Road
Thoraiakkam
Chennai 600 096
Phone: +91-44 2496 6800

Indonesia

PT. GRUNDFOS POMPA
Graha Intirub Lt. 2 & 3
Jln. Cililitan Besar No.454. Makasar,
Jakarta Timur
ID-Jakarta 13650
Phone: +62 21-469-51900
Telefax: +62 21-460 6910 / 460 6901

Ireland

GRUNDFOS (Ireland) Ltd.
Unit A, Merrywell Business Park
Ballymount Road Lower
Dublin 12
Phone: +353-1-4089 800
Telefax: +353-1-4089 830

Italy

GRUNDFOS Pompe Italia S.r.l.
Via Gran Sasso 4
I-20060 Truccazzano (Milano)
Tel.: +39-02-95838112
Telefax: +39-02-95309290 / 95838461

Japan

GRUNDFOS Pumps K.K.
1-2-3, Shin-Miyakoda, Kita-ku,
Hamamatsu
431-2103 Japan
Phone: +81 53 428 4760
Telefax: +81 53 428 5005

Korea

GRUNDFOS Pumps Korea Ltd.
6th Floor, Aju Building 679-5
Yeoksam-dong, Kangnam-ku, 135-916
Seoul, Korea
Phone: +82-2-5317 600
Telefax: +82-2-5633 725

Latvia

SIA GRUNDFOS Pumps Latvia
Deglava biznesa centrs
Augusta Deglava ielā 60, LV-1035, Rīga,
Tālr.: + 371 714 9640, 7 149 641
Fakss: + 371 914 9646

Lithuania

GRUNDFOS Pumps UAB
Smolensko g. 6
LT-03201 Vilnius
Tel: + 370 52 395 430
Fax: + 370 52 395 431

Malaysia

GRUNDFOS Pumps Sdn. Bhd.
7 Jalan Peguam U1/25
Glenmarie Industrial Park
40150 Shah Alam
Selangor
Phone: +60-3-5569 2922
Telefax: +60-3-5569 2866

Mexico

Bombas GRUNDFOS de México S.A. de
C.V.
Boulevard TLC No. 15
Parque Industrial Stiva Aeropuerto
Apodaca, N.L. 66600
Phone: +52-81-8144 4000
Telefax: +52-81-8144 4010

Netherlands

GRUNDFOS Netherlands
Veluwezoom 35
1326 AE Almere
Postbus 22015
1302 CA ALMERE
Tel.: +31-88-478 6336
Telefax: +31-88-478 6332
E-mail: info_gnl@grundfos.com

New Zealand

GRUNDFOS Pumps NZ Ltd.
17 Beatrice Tinsley Crescent
North Harbour Industrial Estate
Albany, Auckland
Phone: +64-9-415 3240
Telefax: +64-9-415 3250

Norway

GRUNDFOS Pumper A/S
Strømsveien 344
Postboks 235, Leirdal
N-1011 Oslo
Tlf.: +47-22 90 47 00
Telefax: +47-22 32 21 50

Poland

GRUNDFOS Pompy Sp. z o.o.
ul. Klonowa 23
Baranowo k. Poznania
PL-62-081 Przeźmierowo
Tel: (+48-61) 650 13 00
Fax: (+48-61) 650 13 50

Portugal

Bombas GRUNDFOS Portugal, S.A.
Rua Calvet de Magalhães, 241
Apartado 1079
P-2770-153 Paço de Arcos
Tel.: +351-21-440 76 00
Telefax: +351-21-440 76 90

Romania

GRUNDFOS Pompe România SRL
Bd. Biruintei, nr 103
Pantelimon county Ilfov
Phone: +40 21 200 4100
Telefax: +40 21 200 4101
E-mail: romania@grundfos.ro

Russia

ООО Грундфос Россия
ул. Школьная, 39-41
Москва, RU-109544, Russia
Тел. (+7) 495 564-88-00 (495) 737-30-00
Факс (+7) 495 564 8811
E-mail grundfos.moscow@grundfos.com

Serbia

Grundfos Srbija d.o.o.
Omladinskih brigada 90b
11070 Novi Beograd
Phone: +381 11 2258 740
Telefax: +381 11 2281 769
www.rs.grundfos.com

Singapore

GRUNDFOS (Singapore) Pte. Ltd.
25 Jalan Tukang
Singapore 619264
Phone: +65-6681 9688
Telefax: +65-6681 9689

Slovakia

GRUNDFOS s.r.o.
Prievozská 4D
821 09 BRATISLAVA
Phona: +421 2 5020 1426
sk.grundfos.com

Slovenia

GRUNDFOS LJUBLJANA, d.o.o.
Leskoškova 9e, 1122 Ljubljana
Phone: +386 (0) 1 568 06 10
Telefax: +386 (0) 1 568 06 19
E-mail: tehnika-si@grundfos.com

South Africa

Grundfos (PTY) Ltd.
16 Lascalles Drive, Meadowbrook Estate
1609 Germiston, Johannesburg
Tel.: (+27) 10 248 6000
Fax: (+27) 10 248 6002
E-mail: lgradidge@grundfos.com

Spain

Bombas GRUNDFOS España S.A.
Camino de la Fuentequilla, s/n
E-28110 Algiete (Madrid)
Tel.: +34-91-848 8800
Telefax: +34-91-628 0465

Sweden

GRUNDFOS AB
Box 333 (Lunnagårdsgatan 6)
431 24 Mölndal
Tel.: +46 31 332 23 000
Telefax: +46 31 331 94 60

Switzerland

GRUNDFOS Pumpen AG
Bruggacherstrasse 10
CH-8117 Fällanden/ZH
Tel.: +41-44-806 8111
Telefax: +41-44-806 8115

Taiwan

GRUNDFOS Pumps (Taiwan) Ltd.
7 Floor, 219 Min-Chuan Road
Taichung, Taiwan, R.O.C.
Phone: +886-4-2305 0868
Telefax: +886-4-2305 0878

Thailand

GRUNDFOS (Thailand) Ltd.
92 Chaloe Phrakiat Rama 9 Road,
Dokmai, Pravej, Bangkok 10250
Phone: +66-2-725 8999
Telefax: +66-2-725 8998

Turkey

GRUNDFOS POMPA San. ve Tic. Ltd. Sti.
Gebze Organize Sanayi Bölgesi
İhsan dede Caddesi,
2. yol 200. Sokak No. 204
41490 Gebze/ Kocaeli
Phone: +90 - 262-679 7979
Telefax: +90 - 262-679 7905
E-mail: satis@grundfos.com

Ukraine

Бізнес Центр Європа
Столицне шосе, 103
м. Київ, 03131, Україна
Телефон: (+38 044) 237 04 00
Факс.: (+38 044) 237 04 01
E-mail: ukraine@grundfos.com

United Arab Emirates

GRUNDFOS Gulf Distribution
P.O. Box 16768
Jebel Ali Free Zone
Dubai
Phone: +971 4 8815 166
Telefax: +971 4 8815 136

United Kingdom

GRUNDFOS Pumps Ltd.
Grovebury Road
Leighton Buzzard/Beds. LU7 4TL
Phone: +44-1525-850000
Telefax: +44-1525-850011

U.S.A.

GRUNDFOS Pumps Corporation
9300 Loiret Blvd.
Lenexa, Kansas 66219
Phone: +1-913-227-3400
Telefax: +1-913-227-3500

Uzbekistan

Grundfos Tashkent, Uzbekistan The
Representative Office of Grundfos
Kazakhstan in Uzbekistan
38a, Oybek street, Tashkent
Телефон: (+998) 71 150 3290 / 71 150
3291
Факс: (+998) 71 150 3292

Addresses Revised 15.01.2019

99462941 1119

ECM: 1275702

Trademarks displayed in this material, including but not limited to Grundfos, the Grundfos logo and "be think innovate" are registered trademarks owned by The Grundfos Group. All rights reserved. © 2019 Grundfos Holding A/S, all rights reserved.