

MAGNA3

Installation and operating instructions



English (GB) Installation and operating instructions

Original installation and operating instructions

These installation and operating instructions describe MAGNA3 model D.

Sections 1-5 give the information necessary to be able to unpack, install and start up the product in a safe way.

Sections 6-13 give important information about the product, as well as information on service, fault finding and disposal of the product.

CONTENTS

	Page		
1. General information	3	9. Servicing the product	50
1.1 Hazard statements	3	9.1 Differential-pressure and temperature sensor	50
1.2 Notes	3	9.2 External sensor condition	50
1.3 Safety symbols on the pump	3	9.3 Disassembling the plug	50
2. Receiving the product	3	10. Fault finding the product	51
2.1 Inspecting the product	3	10.1 Grundfos Eye operating indications	51
2.2 Scope of delivery	3	10.2 Fault finding table	52
2.3 Lifting the pump	4	10.3 Fault finding	53
3. Installing the product	5	11. Accessories	54
3.1 Location	5	11.1 Grundfos GO	54
3.2 Tools	5	11.2 Communication interface module, CIM	54
3.3 Mechanical installation	5	11.3 Counterflanges	59
3.4 Positioning the pump	6	11.4 External sensors	60
3.5 Control box positions	6	11.5 Cable for sensors	60
3.6 Pump head position	7	11.6 Blanking flange	61
3.7 Changing the control box position	7	11.7 Insulating kits for air-conditioning and cooling systems	61
3.8 Electrical installation	9	12. Technical data	61
3.9 Wiring diagrams	10	12.1 Sensor specifications	62
3.10 Connecting the power supply, plug-connected versions	12	13. Disposing of the product	63
3.11 Connecting the power supply, terminal-connected versions	13		
3.12 Connecting the external control	14		
4. Starting up the product	15		
4.1 Single-head pump	15		
4.2 Twin-head pump	16		
5. Handling and storing the product	16		
5.1 Frost protection	16		
6. Product introduction	17		
6.1 Applications	17		
6.2 Pumped liquids	17		
6.3 Pump heads in twin-head pumps	17		
6.4 Identification	18		
6.5 Model type	18		
6.6 Radio communication	18		
6.7 Closed valve operation	18		
6.8 Insulating shells	19		
6.9 Non-return valve	19		
7. Control functions	20		
7.1 Quick overview of control modes	20		
7.2 Operating modes	22		
7.3 Control modes	22		
7.4 Additional control mode features	26		
7.5 Multipump modes	27		
7.6 Flow estimation accuracy	28		
7.7 External connections	29		
7.8 Priority of settings	29		
7.9 Input and output communication	30		
8. Setting the product	34		
8.1 Operating panel	34		
8.2 Menu structure	34		
8.3 Startup guide	34		
8.4 Menu overview	36		
8.5 "Home" menu	38		
8.6 "Status" menu	38		
8.7 "Settings" menu	39		
8.8 "Assist" menu	48		
8.9 "Description of control mode"	49		
8.10 "Assisted fault advice"	49		



Read this document and the quick guide before installing the product. Installation and operation must comply with local regulations and accepted codes of good practice.



This appliance can be used by children aged from 8 years and above and persons with reduced physical, sensory or mental capabilities or lack of experience and knowledge if they have been given supervision or instruction concerning use of the appliance in a safe way and understand the hazards involved.

Children shall not play with the appliance. Cleaning and user maintenance shall not be made by children without supervision.

1. General information

1.1 Hazard statements

The symbols and hazard statements below may appear in Grundfos installation and operating instructions, safety instructions and service instructions.



DANGER

Indicates a hazardous situation which, if not avoided, will result in death or serious personal injury.



WARNING

Indicates a hazardous situation which, if not avoided, could result in death or serious personal injury.



CAUTION

Indicates a hazardous situation which, if not avoided, could result in minor or moderate personal injury.

The hazard statements are structured in the following way:



SIGNAL WORD

Description of hazard

Consequence of ignoring the warning.
- Action to avoid the hazard.

1.2 Notes

The symbols and notes below may appear in Grundfos installation and operating instructions, safety instructions and service instructions.



Observe these instructions for explosion-proof products.



A blue or grey circle with a white graphical symbol indicates that an action must be taken.



A red or grey circle with a diagonal bar, possibly with a black graphical symbol, indicates that an action must not be taken or must be stopped.



If these instructions are not observed, it may result in malfunction or damage to the equipment.



Tips and advice that make the work easier.

1.3 Safety symbols on the pump



Check the position of the clamp before you tighten it. Incorrect position of the clamp will cause leakage from the pump and damage the hydraulic parts in the pump head.



Fit and tighten the screw that holds the clamp to $8 \text{ Nm} \pm 1 \text{ Nm}$.



Do not apply more torque than specified even though water is dripping from the clamp. The condensed water is most likely coming from the drain hole under the clamp.

2. Receiving the product

2.1 Inspecting the product

Check that the product received is in accordance with the order. Check that the voltage and frequency of the product match the voltage and frequency of the installation site. See section [6.4.1 Nameplate](#).



Pumps tested with water containing anticorrosive additives are taped on the inlet and outlet ports to prevent residual test water from leaking into the packaging. Remove the tape before installing the pump.

2.2 Scope of delivery

2.2.1 Plug-connected single-head pump



The box contains the following items:

- MAGNA3 pump
- insulating shells
- gaskets
- quick guide
- safety instructions
- one ALPHA plug.

2.2.2 Plug-connected twin-head pump



The box contains the following items:

- MAGNA3 pump
- gaskets
- quick guide
- safety instructions
- two ALPHA plugs.

2.2.3 Terminal-connected single-head pump



The box contains the following items:

- MAGNA3 pump
- insulating shells
- gaskets
- quick guide
- safety instructions
- box with terminal and M20 cable gland.

2.2.4 Terminal-connected twin-head pump



The box contains the following items:

- MAGNA3 pump
- gaskets
- quick guide
- safety instructions
- two boxes with terminals and M 20 cable glands.

2.3 Lifting the pump



Observe local regulations concerning limits for manual lifting or handling.

Always lift directly on the pump head or the cooling fins when handling the pump. See fig. 1.

For large pumps, it may be necessary to use lifting equipment. Position the lifting straps as illustrated in fig. 1.

TM06 7225 3216



Fig. 1 Correct lifting of pump

TM05 8159 2013

TM05 5820 3216



Do not lift the pump head by the control box, i.e. the red area of the pump. See fig. 2.



Fig. 2 Incorrect lifting of pump

TM06 6791 2316

TM05 5821 3216

3. Installing the product

3.1 Location

The pump is designed for indoor installation.

Always install the pump in a dry environment where it will not be exposed to drops or splashes, for example water, from surrounding equipment or structures.

As the pump contains stainless-steel parts, it is important that it is not installed directly in environments, such as:

- Indoor swimming pools where the pump would be exposed to the ambient environment of the pool.
- Locations with direct and continuous exposure to a marine atmosphere.
- In rooms where hydrochloric acid (HCl) can form acidic aerosols escaping from, for example, open tanks or frequently opened or vented containers.

The above applications do not disqualify for installation of MAGNA3. However, it is important that the pump is not installed directly in these environments.

Stainless steel variants of MAGNA3 can be used to pump pool water. See section [6.2 Pumped liquids](#).

To ensure sufficient cooling of motor and electronics, observe the following requirements:

- Position the pump in such a way that sufficient cooling is ensured.
- The ambient temperature must not exceed 40 °C.

3.2 Tools

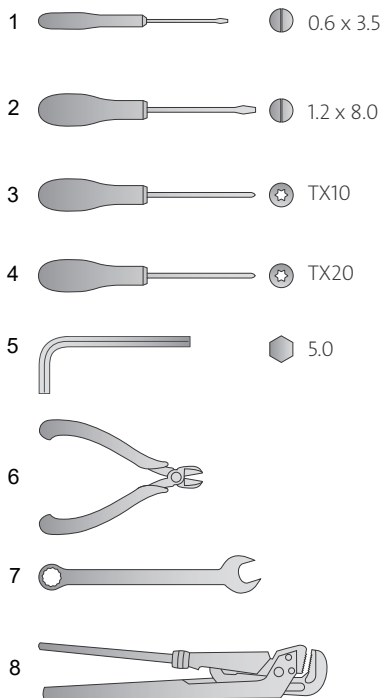

Fig. 3 Recommended tools

Pos.	Tool	Size
1	Screwdriver, straight slot	0.6 x 3.5 mm
2	Screwdriver, straight slot	1.2 x 8.0 mm
3	Screwdriver, torx bit	TX10
4	Screwdriver, torx bit	TX20
5	Hexagon key	5.0 mm
6	Side cutter	
7	Open-end spanner	Depending on DN size
8	Pipe wrench	Only used for pumps with unions

3.3 Mechanical installation

The pump range includes both flanged and threaded versions. These installation and operating instructions apply to both versions, but give a general description of flanged versions. If the versions differ, the threaded version will be described separately. Install the pump so that it is not stressed by the pipes. For maximum permissible forces and moments for pipe connections acting on the pump flanges or threaded connections, see page [64](#).

You can suspend the pump directly in the pipes, provided that the pipes support the pump.

Twin-head pumps are prepared for installation on a mounting bracket or base plate. The pump housing has a M12 thread.

Step	Action	Illustration
1	Arrows on the pump housing indicate the flow direction through the pump. The flow direction can be horizontal or vertical, depending on the control box position.	
2	Close the isolating valves and make sure that the system is not pressurised during the installation of the pump.	
3	Mount the pump with gaskets in the pipes.	

TM05 6472 4712

TM05 2862 3216 - TM05 8456 3216

TM05 2863 3216

TM05 2864 3216

Step	Action	Illustration
4	<p>Flanged version: Fit bolts and nuts. Use the right size of bolts according to system pressure. For further information about torques, see page 64.</p> <p>Threaded version: Tighten the union nuts.</p>	

TM05 2865 3216 - TM05 8455 3216

3.4 Positioning the pump

Always install the pump with horizontal motor shaft.

- Pump installed correctly in a vertical pipe. See fig. 4 (A).
- Pump installed correctly in a horizontal pipe. See fig. 4 (B).
- Do not install the pump with vertical motor shaft. See fig. 4 (C and D).

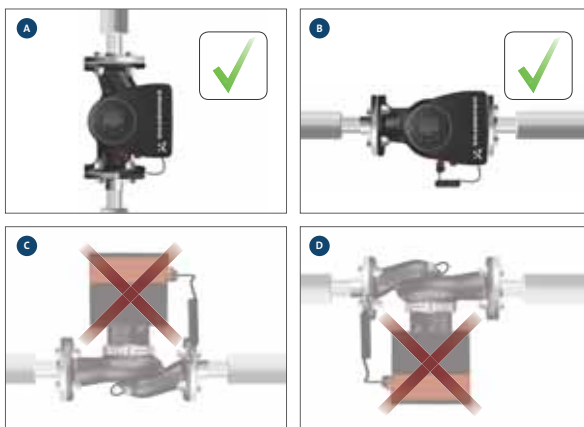

TM05 2866 3216

Fig. 4 Pump installed with horizontal motor shaft

3.5 Control box positions

To ensure adequate cooling, make sure that the control box is in horizontal position with the Grundfos logo in vertical position. See fig. 5.



Make sure that the isolating valves are closed before rotating the control box.

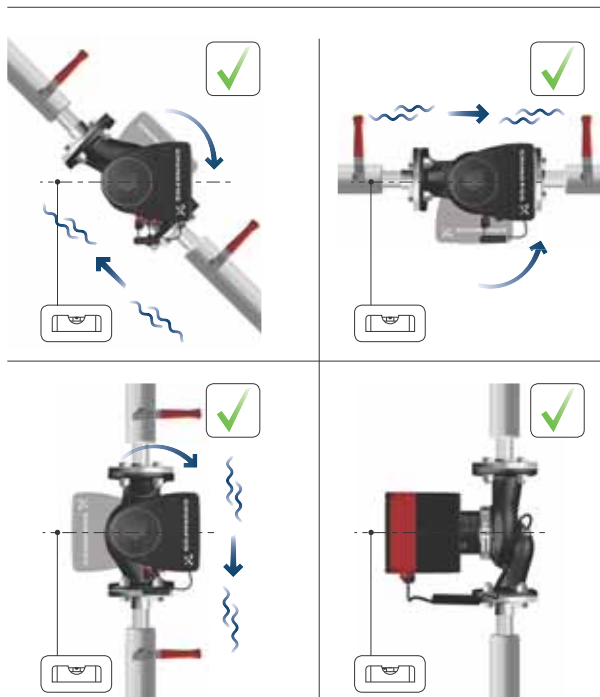

TM05 2915 3216

Fig. 5 Pump with control box in horizontal position



Twin-head pumps installed in horizontal pipes can be fitted with an automatic vent, Rp 1/4, in the upper part of the pump housing if no venting valve is installed in the system. See fig. 6.



TM05 6061 3216

Fig. 6 Automatic vent

3.6 Pump head position

If you remove the pump head before installing the pump in the pipes, pay special attention when fitting the pump head to the pump housing:

1. Visually check that the floating ring in the sealing system is centred. See figs 7 and 8.
2. Gently lower the pump head with rotor shaft and impeller into the pump housing.
3. Make sure that the contact face of the pump housing and that of the pump head are in contact before you tighten the clamp. See fig. 9.



Fig. 7 Correctly centred sealing system



Fig. 8 Incorrectly centred sealing system



Observe the position of the clamp before you tighten it. Incorrect position of the clamp will cause leakage from the pump and damage the hydraulic parts in the pump head. See fig. 9.

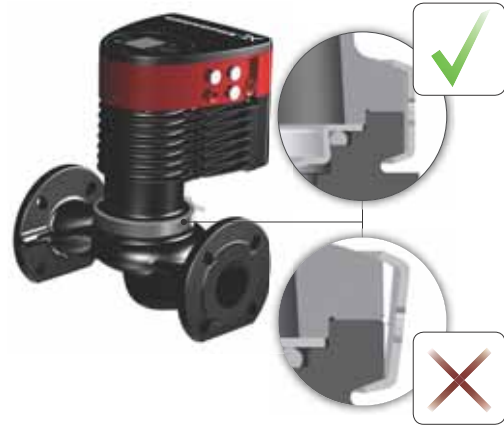

Fig. 9 Fitting the pump head to the pump housing

3.7 Changing the control box position



The warning symbol on the clamp holding the pump head and pump housing together indicates that there is a risk of personal injury. See specific warnings below.

CAUTION

Crushing of feet

Minor or moderate personal injury
- Do not drop the pump head when loosening the clamp.



CAUTION

Pressurised system

Minor or moderate personal injury
- Pay special attention to any escaping vapour when loosening the clamp.



Fit and tighten the screw that holds the clamp to 8 Nm \pm 1 Nm. Do not apply more torque than specified even though water is dripping from the clamp. The condensed water is most likely coming from the drain hole under the clamp.



Check the position of the clamp before you tighten the clamp. Incorrect position of the clamp will cause leakage from the pump and damage the hydraulic parts in the pump head.







Make sure that the isolating valves are closed before rotating the control box.

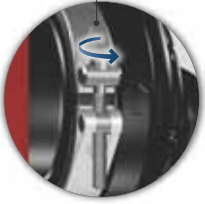

TM05 6650 3216

TM05 6651 32162

TM05 5837 3216

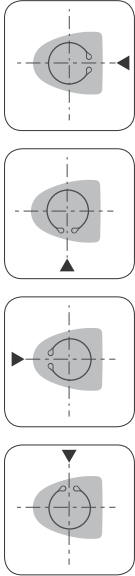
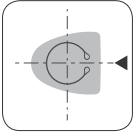
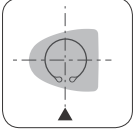
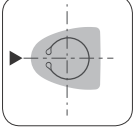
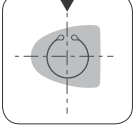
Step	Action	Illustration
1	Loosen the screw in the clamp that holds the pump head and pump housing together. If you loosen the screw too much, the pump head will be completely disconnected from the pump housing.	 
2	Carefully turn the pump head to the desired position. If the pump head is stuck, loosen it with a light blow of a rubber mallet.	
3	Place the control box in horizontal position so that the Grundfos logo is in vertical position. The motor shaft must be in horizontal position.	
4	Due to the drain hole in the stator housing, position the gap of the clamp as shown in step 4a or 4b.	 
4a	Single-head pump. Position the clamp so that the gap points towards the arrow. It can be in position 3, 6, 9 or 12 o'clock.	   







TM05 2867 3216

TM05 2868 3216

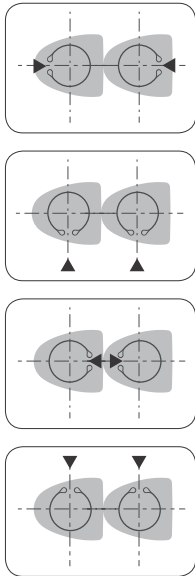
TM05 2869 3216

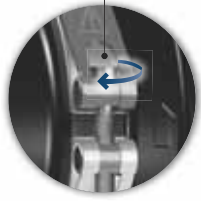
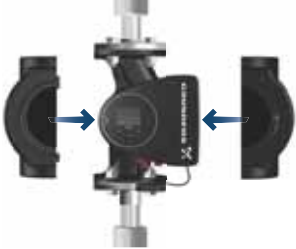
TM05 2870 0612

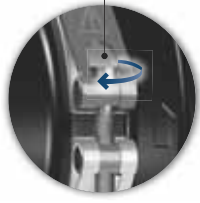
TM05 2918 3216

Step	Action	Illustration
4b	Twin-head pump. Position the clamps so that the gaps point towards the arrows. They can be in position 3, 6, 9 or 12 o'clock.	   
5	Fit and tighten the screw that holds the clamp to 8 Nm ± 1 Nm. Do not retighten the screw if condensed water is dripping from the clamp.	 
6	Fit the insulating shells. The insulating shells for pumps in air-conditioning and cooling systems must be ordered separately.	

TM05 2917 3216

TM05 2872 0612

TM05 2874 3216

As an alternative to insulating shells, you can insulate the pump housing and pipes as illustrated in fig. 10.



In heating systems, do not insulate the control box or cover the operating panel.



Fig. 10 Insulating the pump housing and pipe in a heating system

TMO5 2889 3216

3.8 Electrical installation

Carry out the electrical connection and protection according to local regulations.

Check that the supply voltage and frequency correspond to the values stated on the nameplate.

WARNING

Electric shock



Death or serious personal injury

- Before starting any work on the product, make sure that the power supply has been switched off. Lock the main switch in position 0. Type and requirements as specified in EN 60204-1, 5.3.2.

WARNING

Electric shock

Death or serious personal injury

- Connect the pump to an external main switch with a minimum contact gap of 3 mm in all poles.
- Use earthing or neutralisation for protection against indirect contact.
- If a plug-connected pump is connected to an electric installation where an electrical circuit breaker (voltage sensing ELCB, residual-current device RCD or residual-current circuit device RCCB) is used as an additional protection, this circuit breaker must be marked with the first or both of the symbols shown below.

If the pump is terminal-connected, the circuit breaker must be marked with both of the symbols below.



Make sure that the fuse is dimensioned according to the nameplate and local legislation.



Connect all cables in accordance with local regulations.



Make sure that all cables are heat-resistant up to 75 °C.

Install all cables in accordance with EN 60204-1 and EN 50174-2:2000.

- Make sure that the pump is connected to an external main switch.
- The pump requires no external motor protection.
- The motor incorporates thermal protection against slow overloading and blocking (IEC 34-11: TP 211).
- When switched on via the power supply, the pump starts after approximately 5 seconds.

3.8.1 Supply voltage

1 x 230 V ± 10 %, 50/60 Hz, PE.

The voltage tolerances are intended for mains-voltage variations. Do not use the voltage tolerances for running pumps at other voltages than those stated on the nameplate.

3.9 Wiring diagrams

3.9.1 Connection to power supply, plug-connected versions

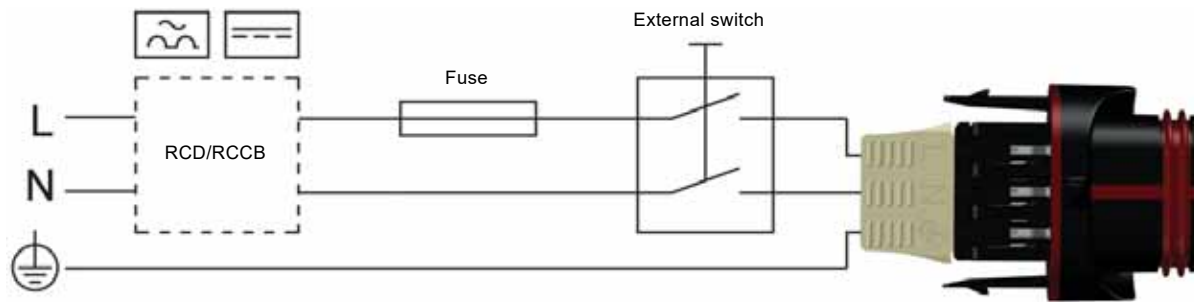

Fig. 11 Example of plug-connected motor with main switch, backup fuse and additional protection

TM05 5277 3712

3.9.2 Connection to external controllers, plug-connected versions

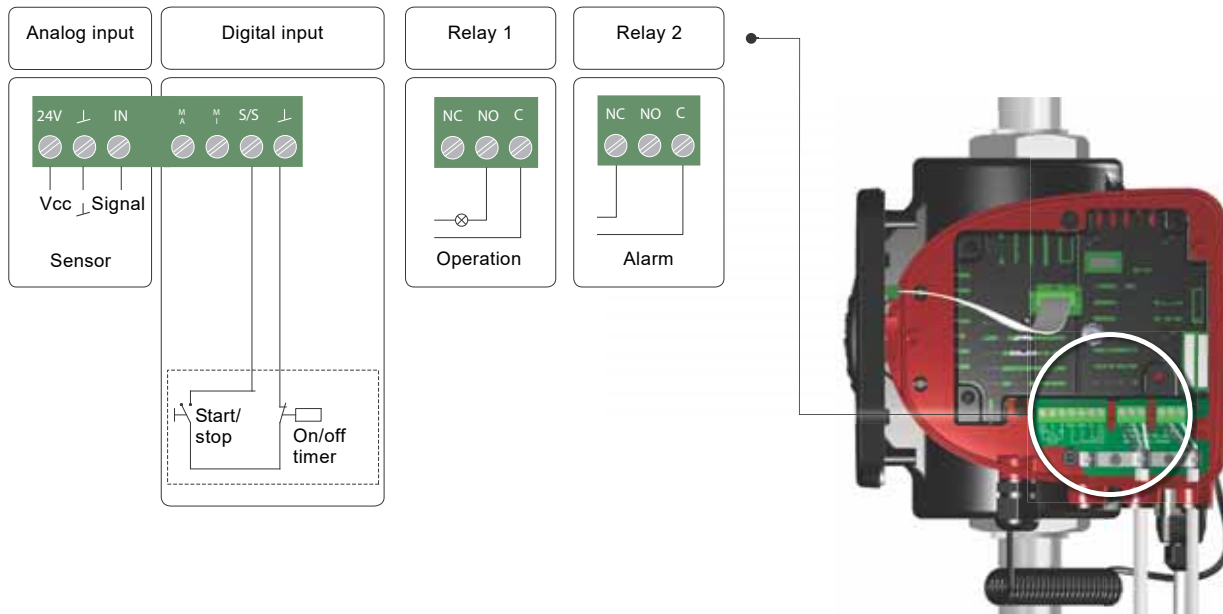

Fig. 12 Example of connections in the control box of plug-connected versions

TM07 0380 1518



Use C and NC for fault signals as this enables serial connections of more relays and detection of signal cable defects.

The connection terminals of plug-connected versions (fig. 12) differ from those of terminal-connected versions (fig. 13), but they have the same function and connection options.

3.9.3 Connections in the control box, terminal-connected versions

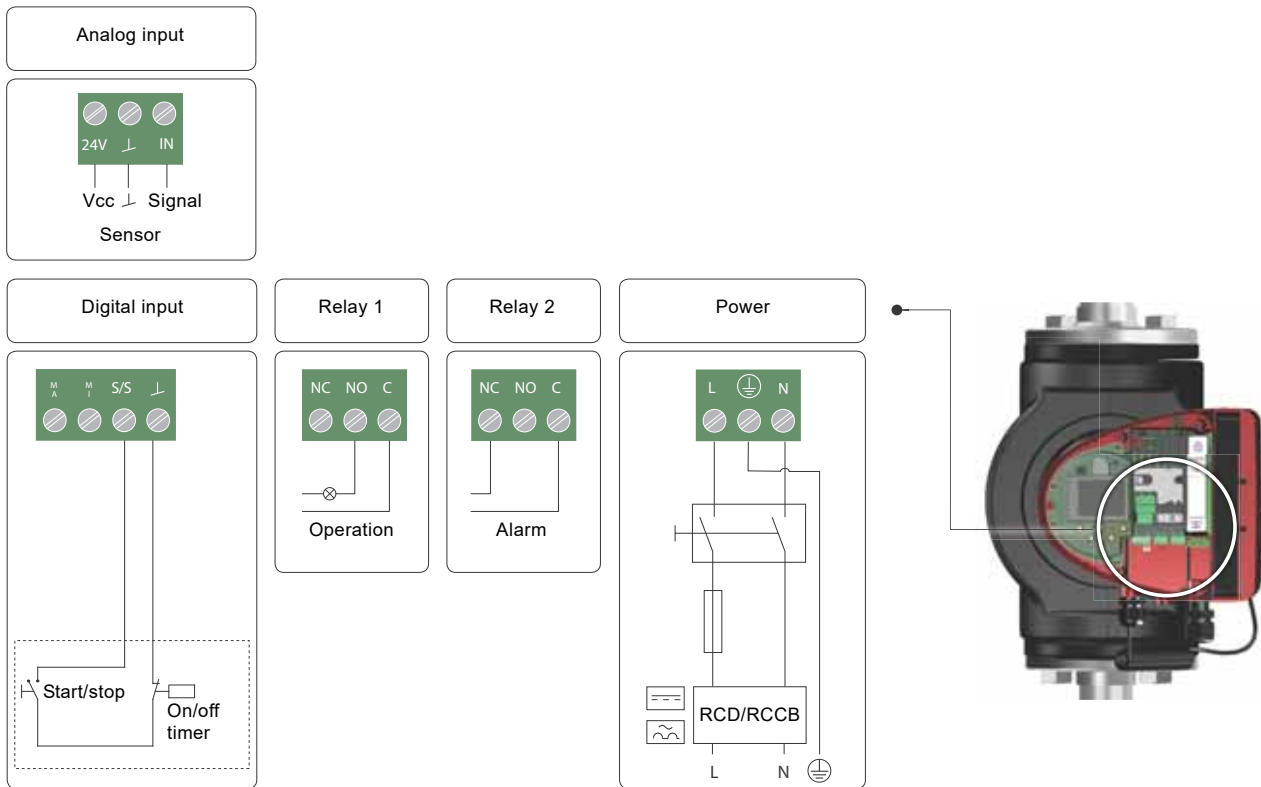

Fig. 13 Example of connections in the control box of terminal-connected versions



Use C and NC for fault signals as this enables serial connections of more relays and detection of signal cable defects.

For further information on digital and analog inputs, see sections [7.9.3 Digital inputs](#) and [7.9.4 Analog input](#).

For information on relay outputs, see section [7.9.2 Relay outputs](#).



TM07 0364 1518

3.10 Connecting the power supply, plug-connected versions

Step	Action	Illustration
1	Fit the cable gland and plug cover to the cable. Strip the cable conductors as illustrated.	<p>7 mm 12 mm 17 mm 0.5-1.5 mm² Ø 5.5-10 mm</p> <p>TM05 5538 3216</p>
2	Connect the cable conductors to the power supply plug.	<p>TM05 5539 3812</p>
3	Bend the cable with the cable conductors pointing upwards.	<p>TM05 5540 3812</p>
4	Pull out the conductor guide plate and throw it away.	<p>TM05 5541 3812</p>
5	Click the plug cover onto the power supply plug.	<p>Click Click</p> <p>TM05 5542 3812</p>
6	Screw the cable gland onto the power supply plug.	<p>TM05 5543 3812</p>

Step	Action	Illustration
7	Insert the power supply plug into the male plug in the pump control box.	<p>TM05 8454 2313</p>

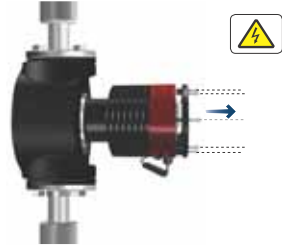
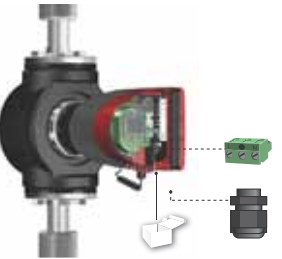
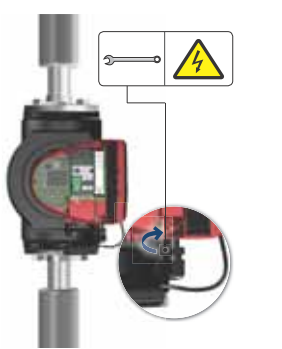

3.11 Connecting the power supply, terminal-connected versions

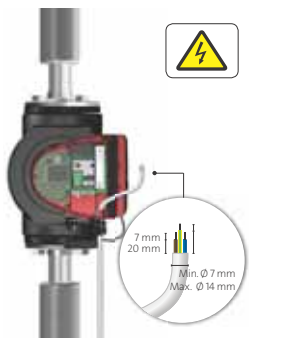
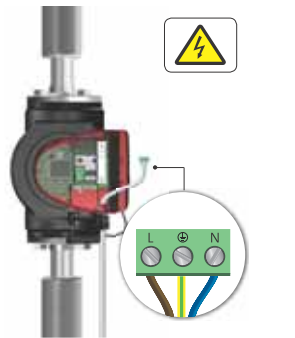
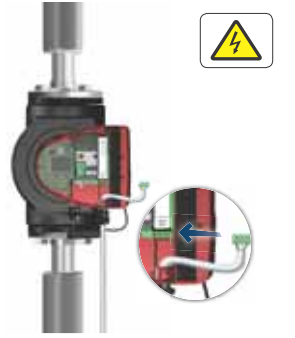
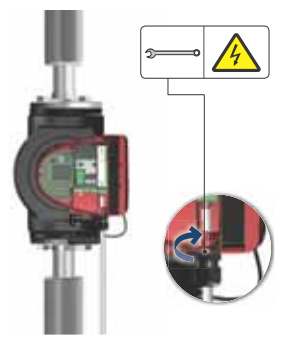
Step	Action	Illustration
1	Remove the front cover from the control box. Do not remove the screws from the cover.	 TM05 2875 3416
2	Locate the power supply plug and cable gland in the small cardboard box supplied with the pump.	 TM05 2876 3416
3	Connect the cable gland to the control box.	 TM05 2877 3416
4	Pull the power supply cable through the cable gland.	 TM05 2878 3416

Step	Action	Illustration
5	Strip the cable conductors as illustrated.	 TM05 2879 3416
6	Connect the cable conductors to the power supply plug.	 TM05 2880 3416
7	Insert the power supply plug into the male plug in the pump control box.	 TM05 2881 3416
8	Tighten the cable gland. Fit the front cover.	 TM05 2882 3416

3.12 Connecting the external control

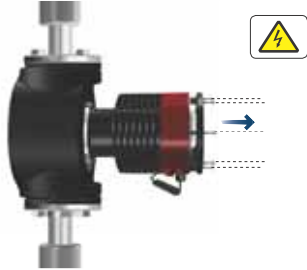
The example is based on a MAGNA3 terminal-connected version. The connection terminals of plug-connected versions differ from those of terminal-connected versions, but they have the same function and connection options. See sections [3.9 Wiring diagrams](#) and [7.9 Input and output communication](#).

Step	Action	Illustration
1	Remove the front cover from the control box. Do not remove the screws from the cover.	
2	Locate the digital input terminal connector.	
3	Pull the cable through a M16 cable gland and one of the cable entries on the pump. Take out the desired terminal, connect the cable conductors and reinsert the terminal. See sections 7.7 External connections and 7.9 Input and output communication for instructions on how to connect the cable to the different terminals in the pump.	

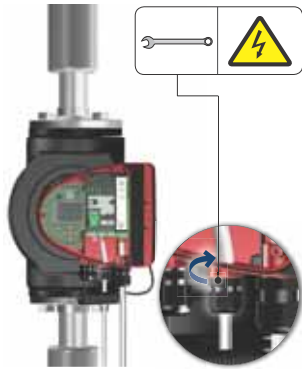
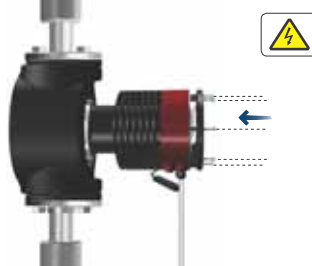
Step	Action	Illustration
4	Tighten the cable gland.	
5	Refit the front cover to the control box.	

4. Starting up the product





4.1 Single-head pump



The number of starts and stops via the power supply must not exceed four times per hour.

Do not start the pump until the system has been filled with liquid and vented. Furthermore, the required minimum inlet pressure must be available at the pump inlet. See section [12. Technical data](#).

The pump is self-venting through the system, and the system must be vented at the highest point.

Step	Action	Illustration
1	Switch on the power supply to the pump. The pump has been factory set to "AUTO _{ADAPT} " mode, which starts after approximately 5 seconds.	
2	Operating panel at first startup. After a few seconds, the pump display changes to the startup guide.	
3	The startup guide guides you through the general settings of the pump, such as language, date and time. If you do not touch the buttons on the operating panel for 15 minutes, the display goes into sleep mode. When you touch a button, the "Home" display appears.	
4	When you have made the general settings, select the desired control mode or let the pump run in AUTO _{ADAPT} mode. For additional settings, see section 7. Control functions .	

TM05 2884 0612

TM05 2885 3216

TM05 2886 3216

TM05 2887 3216

4.2 Twin-head pump



TM05 8894 2813

Fig. 14 MAGNA3 D

The pumps are paired from factory. When switching on the power supply, the heads will establish connection. Please allow approximately 5 seconds for this to happen.

4.2.1 Multipump pairing

Note: Available for pumps with production code from 1838.

After turning on the power supply, the pump's initial setup menu asks you whether or not you want to keep multipump system activated. Several scenarios can play out.

Keep multipump system

- **Only one pump head is connected to the power supply.**
If you have not connected both pump heads to the power supply and you choose to keep the multipump system, warning 77 appears in the display. See fig. 15. Connect the second pump head. Once both pumps are on, the pump heads will establish connection and the warning deactivates.
- **Both pump heads are connected to the power supply.**
Configuring is only necessary from one of the pump heads.

Dissolve multipump system

- **Only one pump head is connected to the power supply.**
If you have not connected both pump heads to the power supply and you choose to dissolve the multipump system, the second pump head, if connected to the power supply, will ask you whether or not you want to keep the multipump system. Choose to dissolve the multipump system.
- **Both pump heads are connected to the power supply.**
Configuring is only necessary from one of the pump heads.

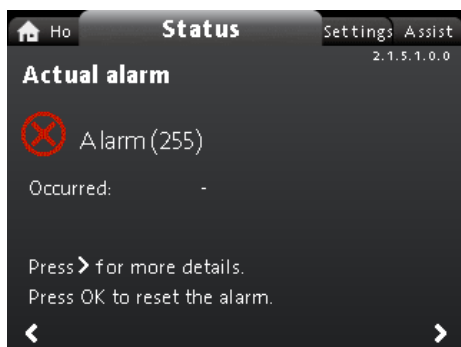

2.1.5.1.0.0 Status

Fig. 15 Warning 77

See sections [7.9.3 Digital inputs](#), [7.9.2 Relay outputs](#) and [7.5 Multipump modes](#) for additional twin-head pump setup options.

4.2.2 Configuring twin-head pumps

If you replace a pump head of a twin-head pump, the twin-head pump will function as two single pumps until you have configured the pump heads and warning 77 is shown in the pump display. See fig. 15.

To establish communication between the pump heads, run the multipump setup via the "Assist" menu. The pump from which you run the setup will be the master pump. See section [8.8.3 "Multipump setup"](#).

5. Handling and storing the product

5.1 Frost protection



If the pump is not used during periods of frost, take the necessary steps to prevent frost bursts.

6. Product introduction

MAGNA3 is a complete range of circulator pumps with integrated controller enabling adjustment of pump performance to the actual system requirements. In many systems, this reduces the power consumption considerably, reduces noise from thermostatic radiator valves and similar fittings and improves the control of the system.

You can set the desired head on the operating panel.

6.1 Applications

The pump is designed for circulating liquids in the following systems:

- heating systems
- domestic hot-water systems
- air-conditioning and cooling systems.

You can also use the pump in the following systems:

- ground-source heat-pump systems
- solar-heating systems.

6.2 Pumped liquids

The pump is suitable for thin, clean, non-aggressive and non-explosive liquids, not containing solid particles or fibres that may attack the pump mechanically or chemically.

In heating systems, the water must meet the requirements of accepted standards on water quality in heating systems, for example the German standard VDI 2035.

The pumps are also suitable for domestic hot-water systems.



Observe local legislation regarding pump housing material.

Stainless steel variants of MAGNA3 can be used to pump pool water with the one of the following properties:

- Chloride (Cl-) \leq 150 mg/l and free chlorine \leq 1.5 mg/l at temperatures \leq 30 degrees Celsius
- Chloride (Cl-) \leq 100 mg/l and free chlorine \leq 1.5 mg/l at temperatures from 30 to 40 degrees Celsius.

We strongly recommend that you use stainless-steel pumps in domestic hot-water applications to avoid corrosion.

In domestic hot-water systems, we recommend that you use the pump only for water with a degree of hardness lower than approximately 14 °dH.

In domestic hot-water systems, we recommend that you keep the liquid temperature below 65 °C to eliminate the risk of lime precipitation.



Do not pump aggressive liquids.



Do not pump flammable, combustible or explosive liquids.

6.2.1 Glycol

You can use the pump for pumping water-ethylene-glycol mixtures up to 50 %.

Example of a water-ethylene-glycol mixture:

Maximum viscosity: 50 cSt ~ 50 % water / 50 % ethylene-glycol mixture at -10 °C.

The pump has a power-limiting function that protects it against overload.

The pumping of water-ethylene-glycol mixtures affects the maximum curve and reduces the performance, depending on the water-ethylene-glycol mixture and the liquid temperature.

To prevent the ethylene-glycol mixture from degrading, avoid temperatures exceeding the rated liquid temperature and minimise the operating time at high temperatures.

Clean and flush the system before you add the ethylene-glycol mixture.

To prevent corrosion or lime precipitation, check and maintain the ethylene-glycol mixture regularly. If further dilution of the supplied ethylene-glycol is required, follow the glycol supplier's instructions.



Additives with a density and/or kinematic viscosity higher than those/that of water reduce the hydraulic performance



Fig. 16 Pumped liquids, threaded version

TM05 8457 2313

6.3 Pump heads in twin-head pumps

The twin-head pump housing has a flap valve on the outlet side. The flap valve seals off the port of the idle pump housing to prevent the pumped liquid from running back to the inlet side. See fig. 17. Due to the flap valve, there is a difference in the hydraulics between the two pump heads. See fig. 18.



Fig. 17 Twin-head pump housing with flap valve

TM06 1566 2514

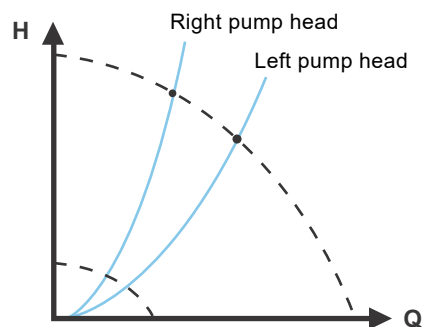

Fig. 18 Hydraulic difference between the two pump heads

TM06 1566 2514

6.4 Identification

6.4.1 Nameplate

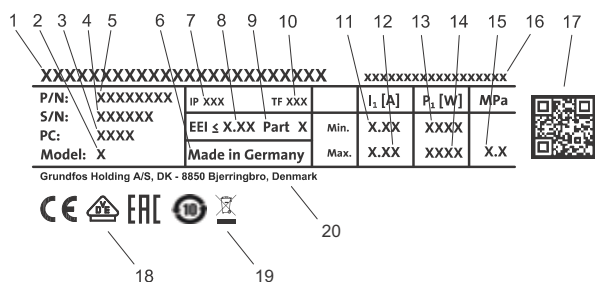

Fig. 19 Example of nameplate

Pos.	Description
1	Product name
2	Model
3	Production code, year and week ¹⁾
4	Serial number
5	Product number
6	Country of manufacture
7	Enclosure class
8	Energy Efficiency Index, EEI
9	Part, according to EEI
10	Temperature class
11	Minimum current [A]
12	Maximum current [A]
13	Minimum power [W]
14	Maximum power [W]
15	Maximum system pressure
16	Voltage [V] and frequency [Hz]
17	QR code
18	CE mark and approvals
19	Crossed-out wheeled bin according to EN 50419:2006
20	Manufacturer's name and address

¹⁾ Example of production code: 1326. The pump was produced in week 26, 2013.



Fig. 20 Production code on packaging

6.5 Model type

These installation and operating instructions cover all models. The model version is stated on the nameplate. See fig. 21.



Fig. 21 Model type on the product

You can see the different model versions in the MAGNA3 data booklet.

6.6 Radio communication

The radio part of this product is a class 1 device and can be used anywhere in the EU member states without restrictions.

Intended use

This pump incorporates a radio for remote control.

The pump can communicate with Grundfos GO and with other MAGNA3 pumps of the same type via the built-in radio.

6.7 Closed valve operation

MAGNA3 pumps can operate at any speed against a closed valve for several days without damage to the pump. However, Grundfos recommends to operate at the lowest possible speed curve to minimize energy losses. There are no minimum flow requirements.



Do not close inlet and outlet valves simultaneously, always keep one open when the pump is running. Media- and ambient temperatures must never exceed the specified temperature range.

6.8 Insulating shells

Insulating shells are available for single-head pumps only.



Limit the heat loss from the pump housing and pipes.

Reduce the heat loss by insulating the pump housing and the pipes. See figs 22 and 10.

- Insulating shells for pumps in heating systems are supplied with the pump.
- Insulating shells for pumps in air-conditioning and cooling systems, down to -10 °C, must be ordered separately. See section 11.7 *Insulating kits for air-conditioning and cooling systems*.

The fitting of insulating shells increases the pump dimensions.



TM05 2859 3216

Fig. 22 Insulating shells

Pumps for heating systems are factory-fitted with insulating shells. Remove the insulating shells before installing the pump.

6.9 Non-return valve

If a non-return valve is fitted in the pipe system, make sure that the set minimum outlet pressure of the pump is always higher than the closing pressure of the valve. See fig. 23. This is especially important in proportional-pressure control mode with reduced head at low flow.



TM05 3055 0912

Fig. 23 Non-return valve

7. Control functions

7.1 Quick overview of control modes

AUTO_{ADAPT}

- Recommended for most heating systems.
- During operation, the pump automatically makes the necessary adjustment to the actual system characteristic.

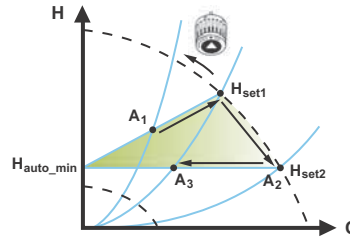

For further information, see section [7.3.2 AUTO_{ADAPT}](#).

FLOW_{ADAPT}

The FLOW_{ADAPT} control mode combines a control mode and a function:

- The pump is running in AUTO_{ADAPT}
- The delivered flow from the pump will never exceed a selected FLOW_{LIMIT}.

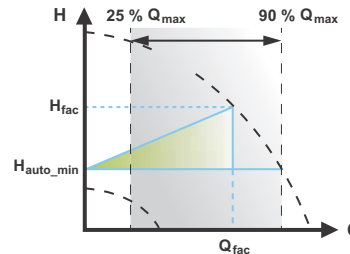

For further information, see section [7.3.3 FLOW_{ADAPT}](#).

Proportional pressure

- Used in systems with relatively large pressure losses in the distribution pipes.
- The head of the pump will increase proportionally to the flow in the system to compensate for the large pressure losses in the distribution pipes.

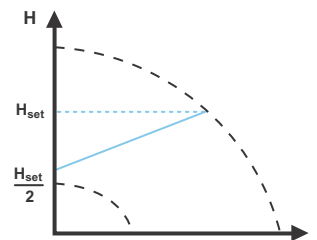

For further information, see section [7.3.4 Proportional pressure](#).

Constant pressure

- We recommend this control mode in systems with relatively small pressure losses.
- The pump head is kept constant, independent of the flow in the system.

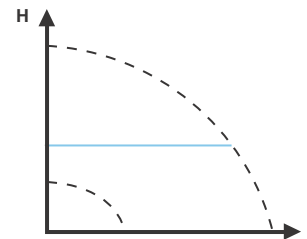

For further information, see section [7.3.5 Constant pressure](#).

Constant temperature

In heating systems with a fixed system characteristic, for example domestic hot-water systems, the control of the pump according to a constant return-pipe temperature is relevant.

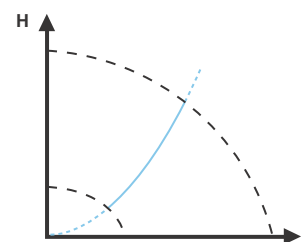

For further information, see section [7.3.6 Constant temperature](#).

Differential temperature

- Ensures a constant differential temperature drop across heating and cooling systems.
- The pump will maintain a constant differential temperature between the pump and the external sensor.

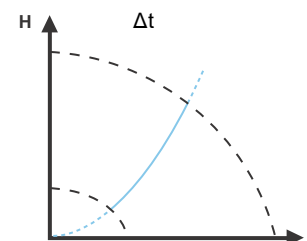

For further information, see section [7.3.7 Differential temperature](#).

Constant flow

Note: Available for pumps with production code from 1838.

- The pump maintains a constant flow in the system independently of the head.
- It is not possible to use an external sensor, instead, the pump uses its internal sensor.

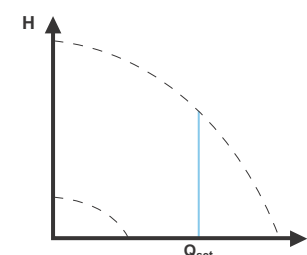

For further information, see section [7.3.8 Constant flow](#).

Constant curve

- The pump can be set to operate according to a constant curve, like an uncontrolled pump.
- Set the desired speed in % of the maximum speed in the range from minimum to 100 %.

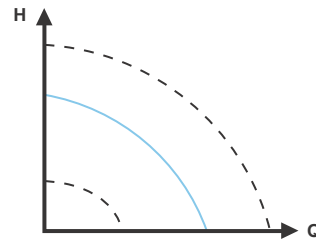

For further information, see section [7.3.9 Constant curve](#).

Multipump modes

- Alternating operation:
Only one pump is operating at a time.
- Backup operation:
One pump is operating continuously. In the event of a fault, the backup pump starts automatically.
- Cascade operation:
Pump performance is automatically adapted to the consumption by switching pumps on and off.

For further information, see section [7.5 Multipump modes](#).

7.2 Operating modes

Normal

The pump runs according to the selected control mode.



You can select the control mode and setpoint even if the pump is not running in Normal mode.

Stop

The pump stops.

Min.

You can use the minimum curve mode in periods in which a minimum flow is required. This operating mode is for instance suitable for manual night setback if automatic night setback is not desired.

Max.

You can use the maximum curve mode in periods in which a maximum flow is required. This operating mode is for instance suitable for hot-water priority.

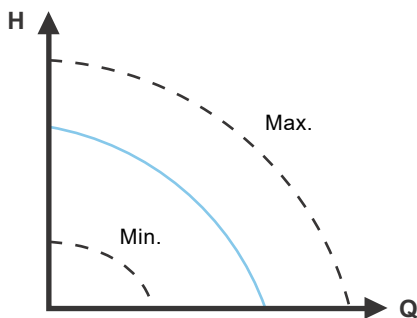

Fig. 24 Maximum and minimum curves

7.3 Control modes

7.3.1 Factory setting

The pumps have been factory-set to $AUTO_{ADAPT}$ without automatic night setback, which is suitable for most installations.

The setpoint has been factory-set.

7.3.2 $AUTO_{ADAPT}$

We recommend the $AUTO_{ADAPT}$ control mode for most heating systems, especially in systems with relatively large pressure losses in the distribution pipes, and in replacement situations where the proportional-pressure duty point is unknown.

This control mode has been developed specifically for heating systems and we do not recommend it for air-conditioning and cooling systems.

Characteristics and key benefits

- Automatically adjusts the pump to actual system characteristics.
- Ensures minimum energy consumption and a low noise level.
- Reduced operating costs and increased comfort.

Technical specifications

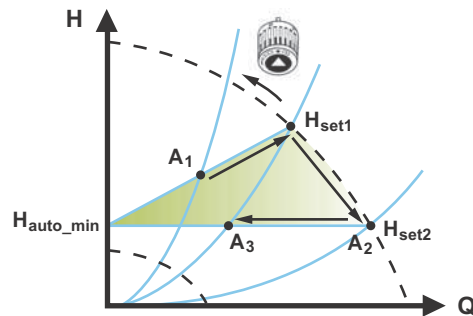

Fig. 25 $AUTO_{ADAPT}$ control

- A_1 : Original duty point.
- A_2 : Lower registered head on the max. curve.
- A_3 : New duty point after $AUTO_{ADAPT}$ control.
- H_{set1} : Original setpoint setting.
- H_{set2} : New setpoint after $AUTO_{ADAPT}$ control.
- H_{auto_min} : A fixed value of 1.5 m.

The $AUTO_{ADAPT}$ control mode is a form of proportional-pressure control where the control curves have a fixed origin, H_{auto_min} . When you have enabled $AUTO_{ADAPT}$, the pump will start with the factory setting, H_{set1} , corresponding to approx. 55 % of its maximum head, and then adjust its performance to A_1 . See fig. 25.

When the pump registers a lower head on the maximum curve, A_2 , the $AUTO_{ADAPT}$ function automatically selects a correspondingly lower control curve, H_{set2} . If the valves in the system close, the pump adjusts its performance to A_3 . See fig. 25.



Manual setting of the setpoint is not possible.

TM05 2446 5111

TM05 2452 1312

7.3.3 FLOW_{ADAPT}

The FLOW_{ADAPT} control mode combines AUTO_{ADAPT} and FLOW_{LIMIT}, meaning that the pump runs AUTO_{ADAPT} while at the same time ensuring that the flow never exceeds the entered FLOW_{LIMIT} value. This control mode is suitable for systems where a maximum flow limit is desired and where a steady flow through the boiler in a boiler system is required. Here, no extra energy is used for pumping too much liquid into the system.

In systems with mixing loops, you can use FLOW_{ADAPT} to control the flow in each loop.

Characteristics and key benefits

- The dimensioned flow for each zone (required heat energy) is determined by the flow from the pump. This flow can be set precisely in the FLOW_{ADAPT} control mode without using throttling valves.
- When the flow is set lower than the balancing valve setting, the pump will ramp down instead of losing energy by pumping against a balancing valve.
- Cooling surfaces in air-conditioning systems can operate at high pressure and low flow.

Note: The pump cannot reduce the flow on the inlet side, but is able to control that the flow on the outlet side is at least the same as on the inlet side. This is due to the fact that the pump has no built-in valve.

Technical specifications

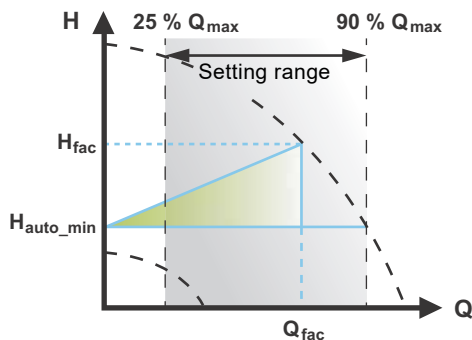

TM05 3334 1312

Fig. 26 FLOW_{ADAPT} control

The factory setting of the FLOW_{ADAPT} is the flow where the AUTO_{ADAPT} factory setting meets the maximum curve. See fig. 26.

The typical pump selection is based on the required flow and calculated pressure losses. The pump is typically oversized by 30 to 40 % to ensure that it can overcome the pressure losses in the system. Under these conditions, the full benefit of AUTO_{ADAPT} cannot be obtained.

To adjust the maximum flow of this "oversized" pump, balancing valves are built into the circuit to increase the resistance and thus reduce the flow.

The FLOW_{ADAPT} function reduces the need for a pump throttling valve, see fig. 27, but does not eliminate the need for balancing valves in heating systems.

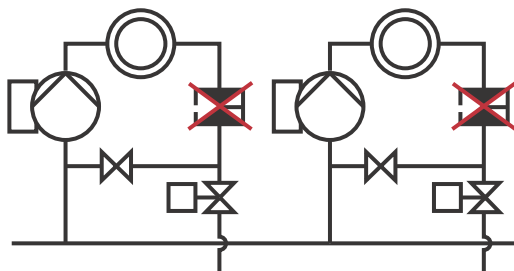

TM05 2685 1212

Fig. 27 Reduced need for a pump throttling valve

7.3.4 Proportional pressure

Proportional pressure is suitable in systems with relatively large pressure losses in the distribution pipes and in air-conditioning and cooling systems:

- Two-pipe heating systems with thermostatic valves and the following:
 - very long distribution pipes
 - strongly throttled pipe balancing valves
 - differential-pressure regulators
 - large pressure losses in those parts of the system where the total quantity of water flows (for example boiler, heat exchanger and distribution pipe up to the first branching).
- Primary circuit pumps in systems with large pressure losses in the primary circuit.
- Air-conditioning systems with the following:
 - heat exchangers (fan coils)
 - cooling ceilings
 - cooling surfaces.

Characteristics and key benefits

- The head of the pump increases proportionally to the flow in the system.
- Compensates for large pressure losses in the distribution pipes.

Technical specifications

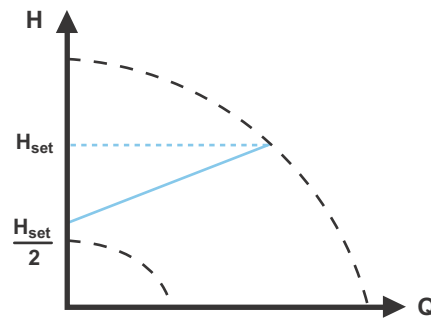

TM05 2448 1212

Fig. 28 Proportional-pressure control

The head is reduced at decreasing flow demand and increased at rising flow demand.

The head against a closed valve is half the setpoint H_{set} . You can set the setpoint with an accuracy of 0.1 metre.

7.3.5 Constant pressure

A constant pressure is advantageous in systems with relatively small pressure losses in the distribution pipes:

- Two-pipe heating systems with thermostatic valves:
 - dimensioned for natural circulation
 - small pressure losses in those parts of the system where the total quantity of water flows (for example boiler, heat exchanger and distribution pipe up to the first branching)
 - modified to a high differential temperature between flow pipe and return pipe (for example district heating).
- Underfloor heating systems with thermostatic valves.
- One-pipe heating systems with thermostatic valves or pipe balancing valves.
- Primary circuit pumps in systems with small pressure losses in the primary circuit.

Characteristics and key benefits

- The pump pressure is kept constant, independent of the flow in the system.

Technical specifications

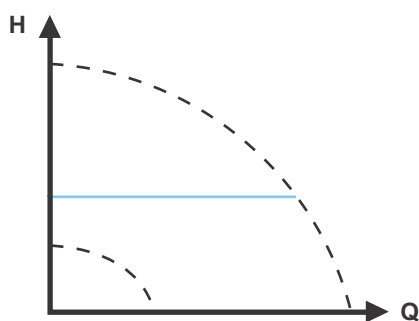

Fig. 29 Constant-pressure control

TM05 2449 0312

7.3.6 Constant temperature

This control mode is suitable in heating systems with a fixed system characteristic, for example domestic hot-water systems, where control of the pump according to a constant return-pipe temperature is relevant.

Characteristics and key benefits

- The temperature is kept constant.
- Use $FLOW_{LIMIT}$ to control the maximum circulation flow.

Technical specifications

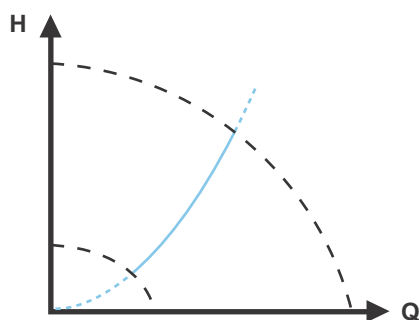

Fig. 30 Constant-temperature control

TM05 2451 5111

When you use this control mode, do not install any balancing valves in the system.

The inverse control for cooling application is available from model B.

Temperature sensor

If the pump is installed in the flow pipe, install an external temperature sensor in the return pipe of the system. See fig. 31. Install the sensor as close as possible to the consumer (radiator, heat exchanger, etc.).

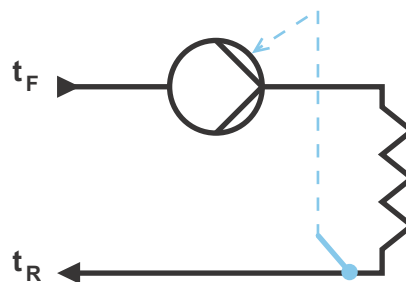

Fig. 31 Pump with external sensor

We recommend that you install the pump in the flow pipe.

If the pump is installed in the return pipe of the system, you can use the internal temperature sensor. In this case, install the pump as close as possible to the consumer (radiator, heat exchanger, etc.).

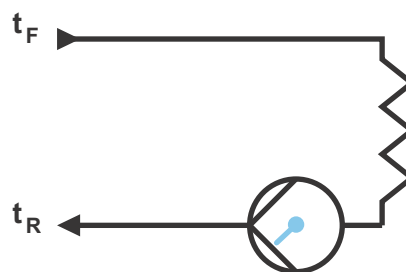

Fig. 32 Pump with internal sensor

Sensor range:

- minimum $-10\text{ }^{\circ}\text{C}$
- maximum $+130\text{ }^{\circ}\text{C}$

To ensure that the pump is able to control the temperature, we recommend that you set the sensor range between -5 and $+125\text{ }^{\circ}\text{C}$.

TM05 2615 0312

TM05 2616 0312

7.3.7 Differential temperature

Select this control mode if the pump performance is to be controlled according to a differential temperature in the system where the pump is installed.

Characteristics and key benefits

- Ensures a constant differential temperature drop across heating and cooling systems.
- Ensures a constant differential temperature between the pump and the external sensor, see figures 33 and 34.
- Requires two temperature sensors, the internal temperature sensor together with an external sensor.

Technical specifications

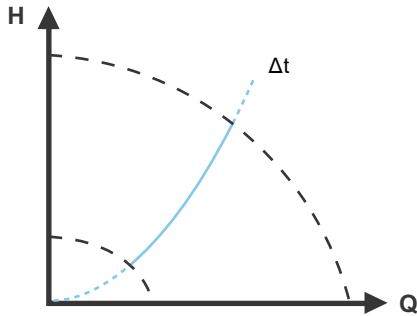

Fig. 33 Differential temperature

The differential-temperature control mode is available in model B. The model version is stated on the nameplate. See section 6.5 Model type.

Temperature sensor

To measure the temperature difference of the flow and return pipe, you must use both the internal sensor and an external sensor.

If the pump is installed in the flow pipe, the external sensor must be installed in the return pipe and vice versa. Always install the sensor as close as possible to the consumer (radiator, heat exchanger, etc.). See fig. 34.

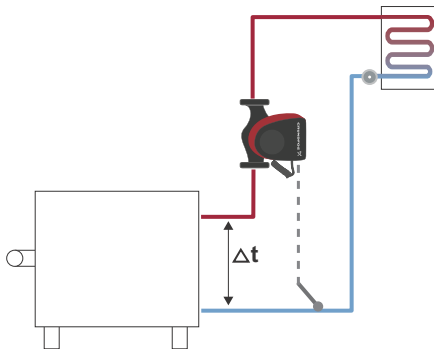

Fig. 34 Differential temperature

TM05 2451 5111

TM05 8236 2113

7.3.8 Constant flow

Note: Available for pumps with production code from 1838.

The pump maintains a constant flow in the system independently of the head. See fig. 35.

Constant flow is suitable in applications such as air handling units, hot-water systems and ground-source heating systems.

Characteristics and key benefits

- It is not possible to use an external sensor, instead, the pump uses its internal sensor.
- In multipump systems constant flow is only available in alternating and backup operation, not cascade operation.

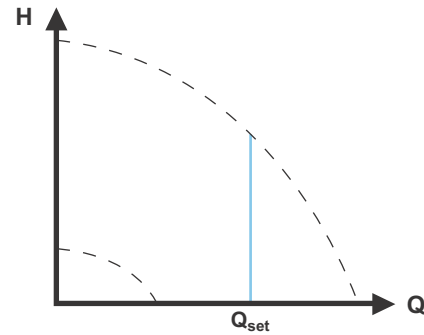

Fig. 35 Constant flow rate

TM05 7955 1713

7.3.9 Constant curve

A constant curve is suitable for systems where there is a demand for both constant flow and constant head, i.e.:

- heating surfaces
- cooling surfaces
- heating systems with 3-way valves
- air-conditioning systems with 3-way valves
- chiller pumps.

Characteristics and key benefits

- If an external controller is installed, the pump is able to change from one constant curve to another, depending on the value of the external signal.
- Depending on your preferences, the pump can be controlled according to either a maximum or minimum curve.

Technical specifications

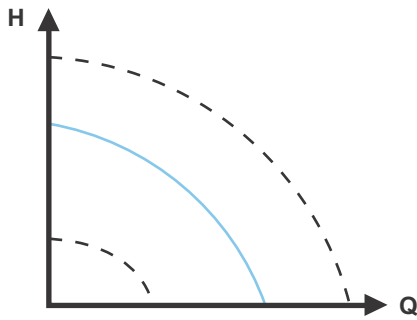

Fig. 36 Constant-curve duty

The pump can be set to operate according to a constant curve, like an uncontrolled pump. See fig. 36.

Depending on the pump model, you can set the desired speed in % of the maximum speed. The span of control depends on the minimum speed, power and pressure limitation of the pump.

If the pump speed is set in the range between minimum and maximum, the power and pressure are limited when the pump is running on the maximum curve. This means that the maximum performance can be achieved at a speed lower than 100 %. See fig. 37.

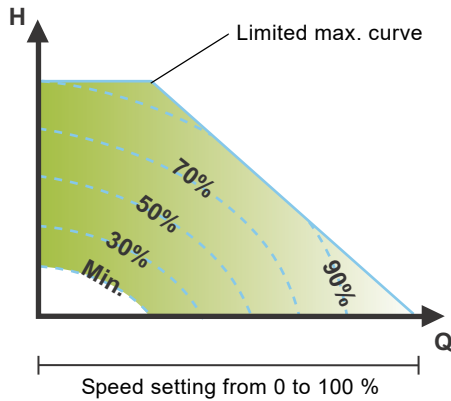

Fig. 37 Power and pressure limitations influencing the maximum curve

You can also set the pump to operate according to the maximum or minimum curve, like an uncontrolled pump:

- You can use the maximum curve mode in periods in which a maximum flow is required. This operating mode is for instance suitable for hot-water priority.
- You can use the minimum curve mode in periods in which a minimum flow is required. This operating mode is for instance suitable for manual night setback if automatic night setback is not desired.

You can select these two operating modes via the digital inputs.

In the control mode constant curve, you can obtain constant flow by choosing a setpoint at 100 % and choosing the desired value for the flow with the flow limit function $FLOW_{LIMIT}$. Take the accuracy of the flow estimation into consideration.

TM05 2446 5111

TM05 4266 2212

7.4 Additional control mode features

MAGNA3 offers additional features for the control modes to meet specific demands.

7.4.1 $FLOW_{LIMIT}$

The feature is an integrated part of the $FLOW_{ADAPT}$ control mode, but can also be used in:

- proportional-pressure mode
- constant-pressure mode
- constant-temperature mode
- constant-curve mode.

Characteristics and key benefits

- A control mode feature that, when activated, ensures that the rated maximum flow is never exceeded.

By enabling $FLOW_{LIMIT}$ in systems where MAGNA3 has full authority, the rated flow is never exceeded, thus eliminating the need for throttling valves.

Technical specifications

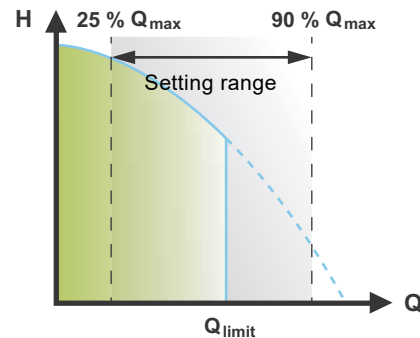

Fig. 38 $FLOW_{LIMIT}$

The factory setting of the $FLOW_{LIMIT}$ is the flow where the $AUTO_{ADAPT}$ factory setting meets the maximum curve.

The setting range for the $FLOW_{LIMIT}$ is 25 to 90 % of the Q_{max} of the pump. Do not set the $FLOW_{LIMIT}$ lower than the dimensioned duty point.

In the flow range between 0 and Q_{limit} , the pump will run according to the selected control mode. When Q_{limit} is reached, the $FLOW_{LIMIT}$ function will reduce the pump speed to ensure that the flow never exceeds the $FLOW_{LIMIT}$ set, no matter if the system requires a higher flow due to increased resistance in the system. See fig. 39, 40 or 41.

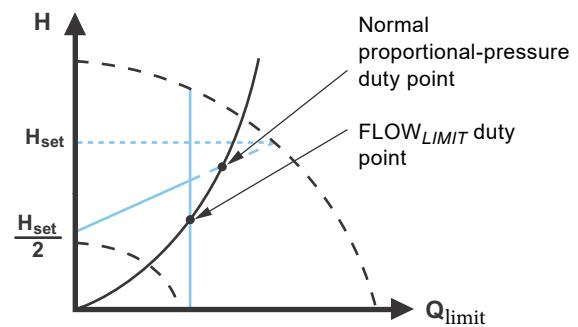

Fig. 39 Proportional-pressure control with $FLOW_{LIMIT}$

TM05 2445 1312

TM05 2543 0412

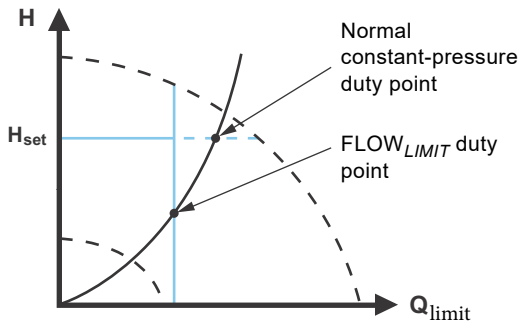

Fig. 40 Constant-pressure control with $FLOW_{LIMIT}$

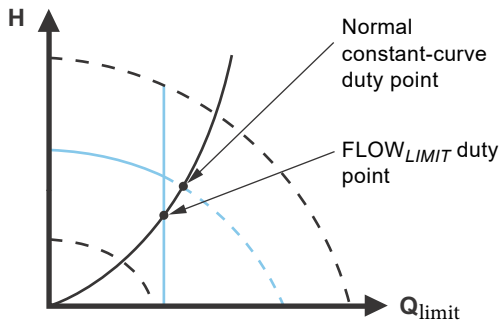

Fig. 41 Constant curve with $FLOW_{LIMIT}$

7.4.2 Automatic night setback

A night setback system is often integrated into a building management system (BMS), or as part of an equivalent electronic control system, which has a built-in timer.

The feature is not beneficial in a room that has underfloor heating because of the regulating inertia of the underfloor heating.

Characteristics and key benefits

- Automatic night setback lowers the room temperature at night, which reduces heating costs.
- The pump automatically changes between normal duty and night setback (duty at low demand) depending on the flow pipe temperature.
- Once activated, the pump runs on the minimum curve.

Technical specifications

The pump automatically changes to night setback when the built-in sensor registers a flow-pipe temperature drop of more than 10 to 15 °C within approximately two hours. The temperature drop must be at least 0.1 °C/min.

Changeover to normal duty takes place without time lag when the temperature has increased by approximately 10 °C.



You cannot enable automatic night setback when the pump is in constant-curve mode.

7.5 Multipump modes

7.5.1 Multipump function

The multipump function enables the control of single-head pumps connected in parallel and twin-head pumps without the use of external controllers. The pump is designed for multipump connection via the wireless GENIair connection. The built-in wireless GENIair module enables communication between pumps and with Grundfos GO without the use of add-on modules. See sections [9. Servicing the product](#) and [11.1 Grundfos GO](#).

Pump system:

- Twin-head pump.
- Two single-head pumps connected in parallel. The pumps must be of equal size and type. Each pump requires a non-return valve in series with the pump.

A multipump system is set via a selected pump, i.e. the master pump (first selected pump). The multipump functions are described in the following sections.

Configuration of twin-head pumps is described in section [4.2 Twin-head pump](#).

For information about input and output communication in a multipump system, see section [7.9.1 External connections in a multipump system](#).

7.5.2 Alternating operation

Only one pump is operating at a time. The change from one pump to the other depends on time or energy. If a pump fails, the other pump will take over automatically.

7.5.3 Backup operation

One pump is operating continuously. The backup pump is operating at intervals to prevent seizing up. If the duty pump stops due to a fault, the backup pump will start automatically.

7.5.4 Cascade operation

Cascade operation ensures that the pump performance is automatically adapted to the consumption by switching pumps on or off. The system thus runs as energy-efficiently as possible with a constant pressure and a limited number of pumps.

The slave pump will start when the master pump is running at maximum or has a fault, and it will stop again when the master pump is running below 50 %.

Cascade operation is available in constant speed and constant pressure. You can with advantage choose a twin-head pump, as the backup pump will start for a short period in peak-load situations.

All pumps in operation will run at equal speed. Pump changeover is automatic and depends on speed, operating hours and faults.

TM05 2444 0312

TM05 2542 0412

7.6 Flow estimation accuracy

The internal sensor estimates the difference in pressure between the inlet and outlet port of the pump. The measurement is not a direct differential-pressure measurement, but by knowing the hydraulic design of the pump, you can estimate the differential pressure across the pump. The speed and power give a direct estimation of the actual duty point at which the pump is running.

The calculated flow rate has an accuracy specified as $\pm xx\%$ of Q_{\max} . The less flow through the pump, the less accurate the reading will be. The typical accuracy of the flow reading is $\pm 5\%$ of the specific pump's maximum flow. In extreme cases, such as closed valve operation, the accuracy can be up to $\pm 10\%$ of the maximum flow.

See also section [7.9.5 Heat energy monitor](#).

Example:

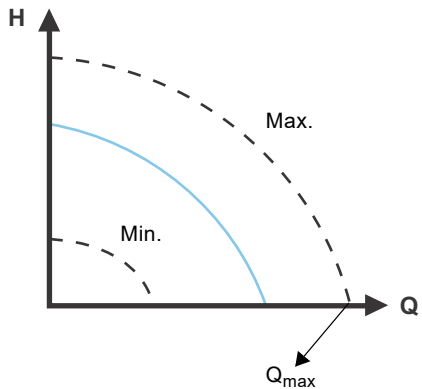

TM05 2448 5111

Fig. 42 Q_{\max}

1. MAGNA3 65-60 has a Q_{\max} of $40 \text{ m}^3/\text{h}$.
Typically 5% accuracy means $2 \text{ m}^3/\text{h}$ inaccuracy of $Q_{\max} \pm 2 \text{ m}^3/\text{h}$.
2. This accuracy is valid for the entire QH area. If the pump indicates $10 \text{ m}^3/\text{h}$, the measurement is $10 \pm 2 \text{ m}^3/\text{h}$.
3. The flow rate can be from $8\text{-}12 \text{ m}^3/\text{h}$.

The use of a mixture of water and ethylene-glycol will reduce the accuracy.

If the flow is less than 10% of Q_{\max} , the display shows a low flow.

7.7 External connections

WARNING

Electric shock



Minor or moderate personal injury
 - Separate wires connected to supply terminals, outputs NC, NO, C and start-stop input from each other and from the supply by reinforced insulation.



Make sure that all cables are heat-resistant up to 75 °C.

Install all cables in accordance with EN 60204-1 and EN 50174-2:2000.



Connect all cables in accordance with local regulations.

The connection terminals of plug-connected versions differ from those of terminal-connected versions, but they have the same function and connection options.

Concerning demands on signal wires and signal transmitters, see section 12. [Technical data](#).

Use screened cables for external on-off switch, digital input, sensor and setpoint signals.

Connect screened cables to the earth connection as follows:

- Terminal-connected versions:
 Connect the cable screen to earth via the digital-input terminal. See fig. 43.
- Plug-connected versions:
 Connect the cable screen to earth via cable clamp. See fig. 44.

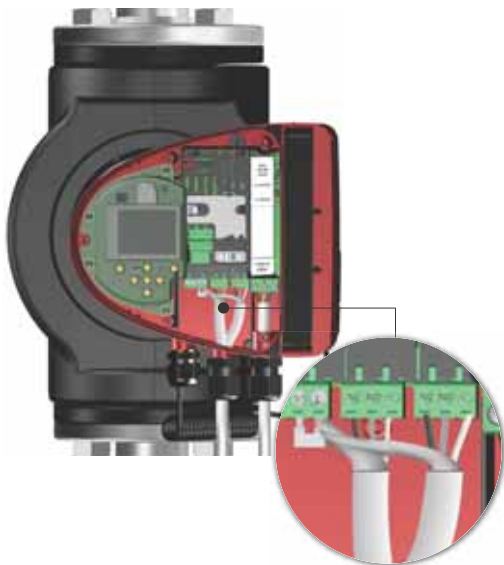

TM05 6060 2313 - TM07 15071518

Fig. 43 Connection of cable screen, terminal-connected versions

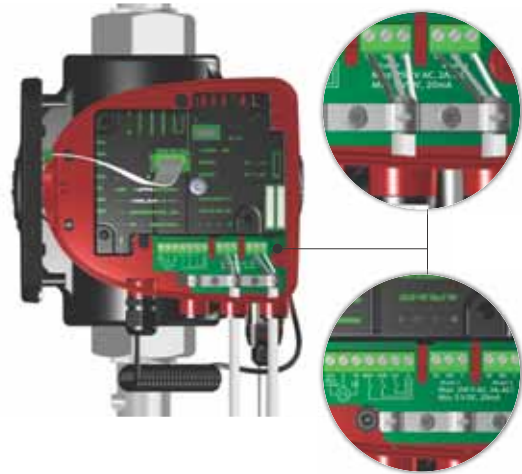

TM05 8539 2413

Fig. 44 Connection of cable screen, plug-connected versions

7.8 Priority of settings

The external forced-control signals influence the settings available on the pump operating panel or with Grundfos GO. However, you can always set the pump to maximum-curve duty or stop the pump on the operating panel or with Grundfos GO.

If two or more functions are enabled at the same time, the pump operates according to the setting with the highest priority.

The priority of the settings is as shown in the table below.

Example: If the pump has been forced to stop via an external signal, the operating panel or Grundfos GO can only set the pump to maximum curve.

Priority	Possible settings		
	Operating panel or Grundfos GO	External signals	Bus signal
1	"Stop"		
2	"Max. curve"		
3		"Stop"	
4			"Stop"
5			"Max. curve"
6			"Min. curve"
7			"Start"
8		"Max. curve"	
9	"Min. curve"		
10		"Min. curve"	
11	"Start"		

7.9 Input and output communication

- Relay outputs
Alarm, ready and operating indication via signal relay.
- Digital input
 - Start and stop (S/S)
To ensure a trouble-free operation, Grundfos recommends using a Solid State Relay with a minimum load current below 1 mA. These relays typically have a MOSFET transistor as output drive. Relays with gold contacts for small signal operation can also be used. Relays with a Thyristor output drive cannot be used.
 - Minimum curve (MI)
 - Maximum curve (MA).
- Analog input
0-10 V or 4-20 mA control signal.
To be used for external control of the pump or as sensor input for the control of the external setpoint.
The 24-V supply from pump to sensor is optional and is normally used when an external supply is not available.



WARNING

Electric shock

- Death or serious personal injury
- Separate input voltages from external equipment from live parts by reinforced insulation.

7.9.1 External connections in a multipump system

The following external connections need only to be fitted to the master pump:

- analog input
- digital input
- communication interface module, CIM
If you want to monitor a slave pump, mount a communication interface module on the slave pump too.

The following external connections need to be fitted on both the master and slave pumps:

- Relays (from model B)

The following are system parameters shared between the pumps:

- Operating mode, control mode and setpoint
- Heat energy monitor:
Both pumps display the heat energy for the entire system and not only for the individual pump. Please note that all calculations are made in the master pump. If the master pump loses power, the heat energy will cease to increment. See also section [7.9.5 Heat energy monitor](#).

For more information about input and output communication in multipump systems, see sections [7.9.2 Relay outputs](#), [7.9.3 Digital inputs](#) and [7.9.4 Analog input](#).

7.9.2 Relay outputs

The pump has two signal relays with a potential-free changeover contact for external fault indication. See section [3.9 Wiring diagrams](#).

You can set the function of the signal relay to "Alarm", "Ready" or "Operation" on the operating panel or with Grundfos GO.

The relays can be used for outputs up to 250 V and 2 A.



Warnings do not activate the alarm relay.



Use C and NC for fault signals as this enables serial connections of more relays and detection of signal cable defects.

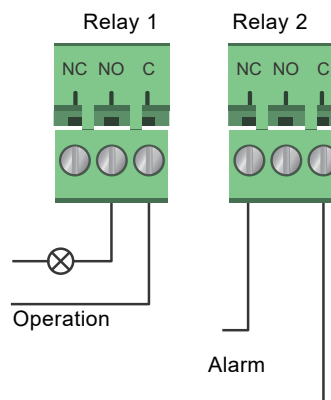

Fig. 45 Relay output

TM05 3338 1212

Contact symbol	Function
NC	Normally closed
NO	Normally open
C	Common

The functions of the signal relays appear from the table below:

Signal relay	Alarm signal
	Not activated: <ul style="list-style-type: none"> • The power supply has been switched off. • The pump has not registered a fault.
	Activated: <ul style="list-style-type: none"> • The pump has registered a fault.
Signal relay	Ready signal
	Not activated: <ul style="list-style-type: none"> • The pump has registered a fault and is unable to run. • The power supply has been switched off.
	Activated: <ul style="list-style-type: none"> • The pump has been set to stop, but is ready to run. • The pump is running.
Signal relay	Operating signal
	Not activated: <ul style="list-style-type: none"> • The power supply has been switched off.
	Activated: <ul style="list-style-type: none"> • The pump is running.

Factory settings of relays:

Relay	Function
1	Operating signal
2	Alarm signal

Relay output in twin-head pumps

The relay output for both the "Alarm", "Ready" and "Operation" functions operates independently on each pump head. If, for example, a fault occurs in one of the pumps, its respective relay is triggered.

7.9.3 Digital inputs

The pump has a digital input for external control of start-stop or forced maximum or minimum curve. See section 3.9 *Wiring diagrams*.

If no external on-off switch is connected, the jumper between terminals start-stop (S/S) and frame (⌋) must be maintained. This connection is the factory setting.

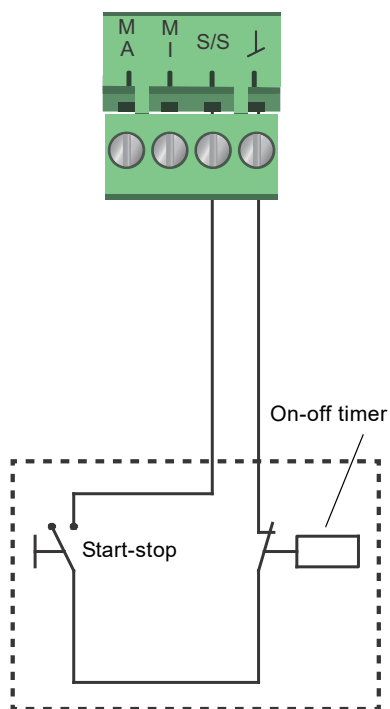
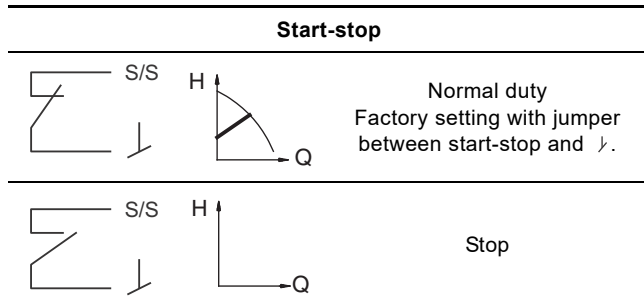

Fig. 46 Digital input

Contact symbol	Function
M	Maximum curve
A	100 % speed
M	Minimum curve
I	
S/S	Start-stop
⌋	Frame connection

External start-stop

You can start and stop the pump via the digital input.



Externally forced maximum or minimum curve

You can force the pump to operate on the maximum or minimum curve via the digital input.

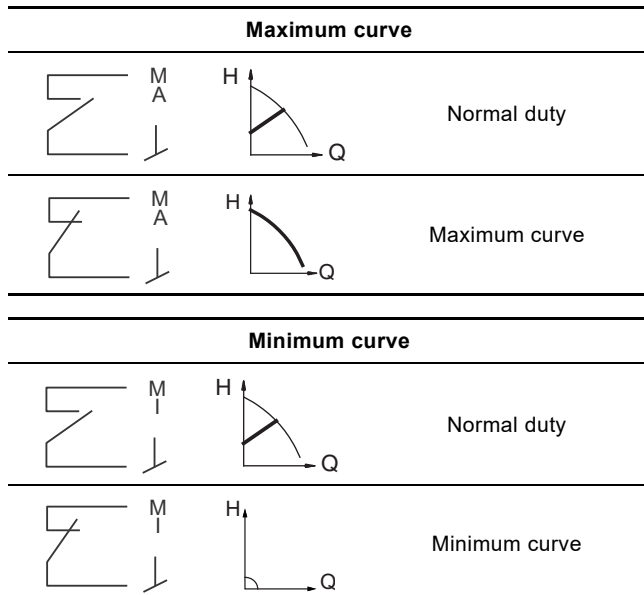

Select the function of the digital input on the pump operating panel or with Grundfos GO.

Digital input on twin-head pumps

The Start/Stop input operates on system level, meaning that if the master pump head receives a stop signal, the system stops.

As a main rule, the digital input is only effective on the master, which is why it is important to know which pump is assigned as master, see fig. 47.

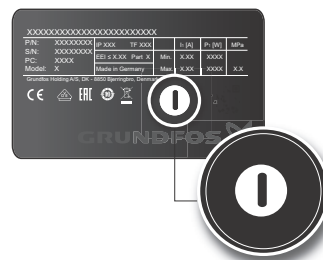

Fig. 47 Identifying the master pump head on the nameplate

For redundancy purposes, the digital input can be used concurrently on the slave pump head. However, as long as the master is powered up, the input on the slave will be ignored. In the event of power loss on the master, the digital input of the slave will take over. When the master pump head is back on, the master takes over and controls the system.

TM05 3339 1212

TM06 6890 2516

7.9.4 Analog input

The pump has an analog input for the connection of an external sensor for measuring temperature or pressure. See section [3.9 Wiring diagrams](#).

You can use sensor types with 0-10 V or 4-20 mA signal.

You can also use the analog input for an external signal for the control from a building management system or similar control system. See fig. 51.

- When the input is used for the heat energy monitor, install a temperature sensor in the return pipe.
- If the pump is installed in the return pipe of the system, install the sensor in the flow pipe.
- If the constant-temperature control mode has been enabled and the pump is installed in the flow pipe of the system, install the sensor in the return pipe.
- If the pump is installed in the return pipe of the system, you can use the internal temperature sensor.

You can change the sensor type, 0-10 V or 4-20 mA, on the operating panel or with Grundfos GO.

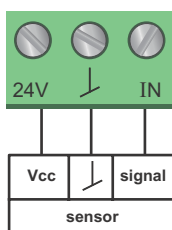

Fig. 48 Analog input for external sensor, 0-10 V

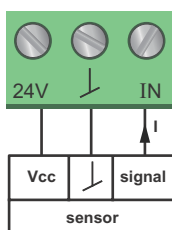

Fig. 49 Analog input for external sensor, 4-20 mA

In order to optimise the pump performance, you can use external sensors in the following cases:

Function or control mode	Sensor type
Heat energy monitor	Temperature sensor
Constant temperature	Temperature sensor
Proportional pressure	Pressure sensor

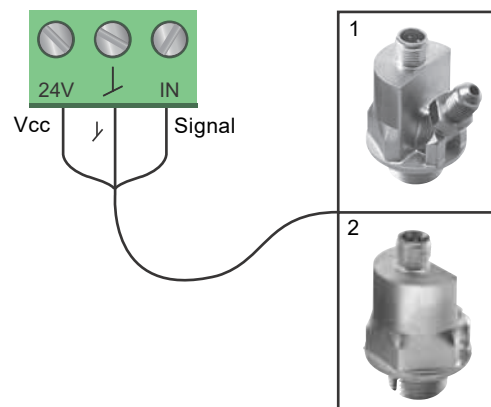

Fig. 50 Examples of external sensors

Pos.	Sensor type
1	Combined temperature and pressure sensor, Grundfos type RPI T2. 1/2" connection and 4-20 mA signal.
2	Pressure sensor, Grundfos type RPI. 1/2" connection and 4-20 mA signal.

For further details, see section [11.4 External sensors](#).

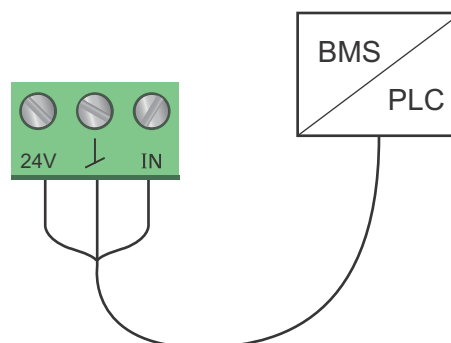

Fig. 51 Examples of external signal for the control via BMS or PLC

Analog input on twin-head pumps

For redundancy purposes, the analog input can be used concurrently on the slave pump head. As long as the master is powered up, the input on the slave will be ignored. However, in the event of power loss on the master, the analog input of the slave will take over. When the master pump head is back on, the master takes over and controls the system.

TMTM06 7237 3416

TM05 3221 0612

TM05 2948 0612

TM05 2888 0612

7.9.5 Heat energy monitor

The heat energy monitor calculates the heat energy consumption within the system. The built-in flow estimation needed for the calculation has a worst case accuracy of $\pm 10\%$ of the maximum flow. The actual accuracy in a duty point will be shown in the MAGNA3 display (available for pumps with production code from 1838). The temperature measurement accuracy also depends on the sensor type. Therefore, you cannot use the heat energy value for billing purposes. However, the value is perfect for optimisation purposes in order to prevent excessive energy costs. See also section 7.6 Flow estimation accuracy.

To counterbalance any inaccuracy on either the internal and external sensor it is possible to manually enter a temperature offset. The offset is entered in integers, for example 2 degrees. The offset range is within ± 20 degrees celsius. To set the temperature offset, see section 8.7.4 "Controller settings".

Note: Temperature sensor offset is available for pumps with production code from 1838.

The flow and volume accuracy is calculated and shown in the display, see sections "Estimated flow rate, accuracy", page 39, and "Accuracy of values", page 39.



The heat energy monitor requires an additional temperature sensor installed in the flow pipe or return pipe depending on where the pump is installed.

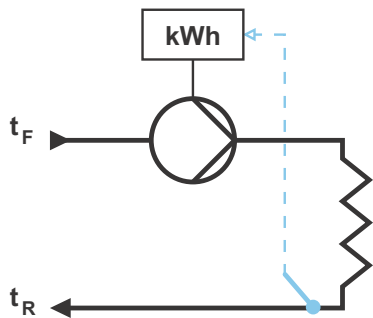

Fig. 52 MAGNA3 with built-in heat energy monitor

You can measure both heating and cooling in the same system. If a system is used for both heating and cooling, two counters are automatically shown in the display. See section "Heat energy", page 39.

Monitoring heat energy in multipump systems

In a multipump system, the master pump calculates the heat energy regardless of which pump, master or slave, is running. If the master loses power or has a fault on the external sensor, the accumulation of heat energy will not be counted until the master is powered back on or the external sensor error is remedied. If the master is replaced, the heat energy values for the system is reset.

7.9.6 External setpoint function

You can use the analog input to influence the setpoint externally. The external setpoint function can be used in two different ways:

- "Linear with Min."
- "Linear with Stop" (available for pumps with production code from 1838)

In both modes the input signal range is influenced linearly.

"Linear with Min."

Here, a 0-10 V or 4-20 mA signal controls the pump speed range in a linear function. The range of control depends on the minimum speed, power and pressure limits of the pump. See figs 53 and 54.

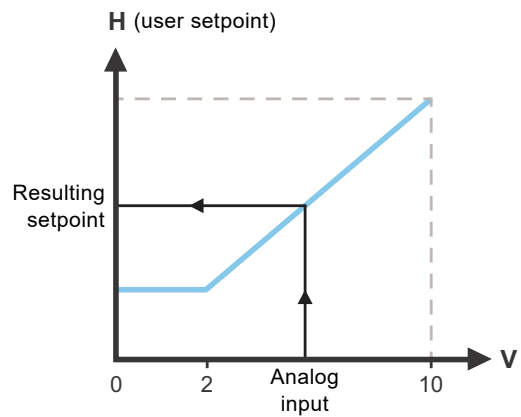

Fig. 53 "Linear with Min.", 0-10 V

Control

0-2 V (0-20 %)	Resulting setpoint is equal to minimum.
2-10 V (20-100 %)	Resulting setpoint is between minimum and user setpoint.

Fig. 54 Control range and setpoint

The external setpoint function operates differently depending on the model. For models A, B and C, the maximum speed is often obtained at voltages lower than 10 V, as the span of control is limited.

In models newer than A, B and C, the internal scaling has been optimised making the dynamic area bigger, thus giving a better control of the pump speed when using the external setpoint function.

The same applies if the pump is receiving a setpoint from Building Management Systems.

"Linear with Stop"

Note: Available for pumps with production code from 1838.

Here, if the input signal is below 10 %, the pump changes to operating mode "Stop". If the input signal is increased above 15 %, the operating mode is changed back to "Normal".

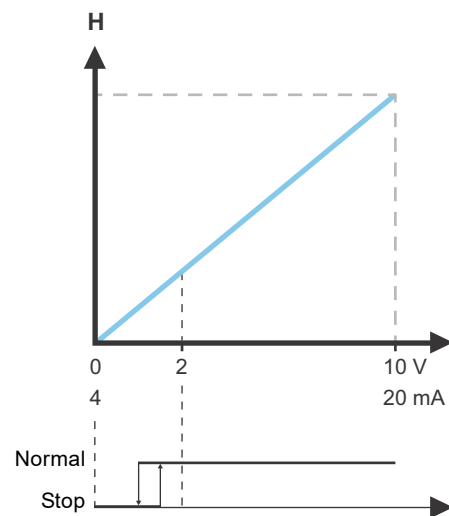

Fig. 55 "Linear with Stop", 0-10 V

TM06 9149 2117

TM05 5367 3612

TM06 9149 2117

8. Setting the product

CAUTION

Hot surface



Minor or moderate personal injury

- At high liquid temperatures, the pump housing may be so hot that only the operating panel may be touched to avoid burns.

8.1 Operating panel



TM05 3820 1612

Fig. 56 Operating panel

Button	Function
	Goes to the "Home" menu.
	Returns to the previous display.
	Navigates between main menus, displays and digits. When the menu is changed, the display always shows the top display of the new menu.
	Navigates between submenus.
	Saves changed values, resets alarms and expands the value field.

8.2 Menu structure

"Home"

This menu shows up to four user-defined parameters with shortcuts or a graphical illustration of a performance curve. See section 8.5 "Home" menu.

Status

This menu shows the status of the pump and system as well as warnings and alarms. See section 8.6 "Status" menu.



You cannot make settings in this menu.



Data is stored once per hour. If the pump is turned off and on via the power supply more frequently than that, the data will be incorrect.

If you need to start and stop the pump more than once per hour, we recommend that you use the operating modes "Stop" and "Normal".

"Settings"

This menu gives access to all setting parameters. You can make a detailed setting of the pump in this menu. See section 8.7 "Settings" menu.

"Assist"

This menu enables assisted pump setup, provides a short description of the control modes and offers fault advice. See section 8.8 "Assist" menu.

- Shortcut to "Control mode" settings
- Shortcut to "Setpoint" settings
- "Estimated flow"
- "Head".

8.3 Startup guide

At first startup you are asked to choose a language after which a startup guide helps you set the date and time.

Follow the instructions given by the display and use the arrows to navigate.

8.3.1 "Multipump pairing", twin-head pumps

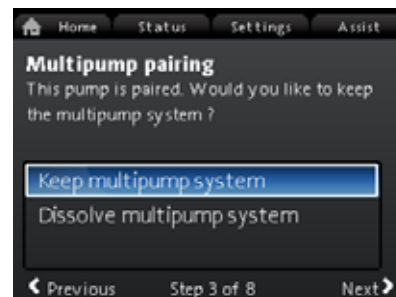

Undef-010

Note: Available for pumps with production code from 1838.

Twin-head pumps are paired from factory. When starting up a twin-head pump for the first time, the startup guide will ask whether or not to keep the multipump system enabled.

Setting

1. Select "Keep multipump system" or "Dissolve multipump system" with or .
2. Press [OK] followed by .
3. Press [OK] to confirm.

The multipump system can be reestablished in the "Assist" menu. See section 8.8.3 "Multipump setup".

8.3.2 "Setting of pump"

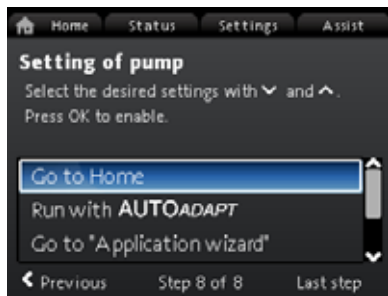

Startupguide_Auto_Adapt_1

Fig. 57 Startup guide: Setting of the pump

"Run with AUTOADAPT"

If you choose "Run with AUTOADAPT", the pump operates according to its factory settings. See section [7.3.1 Factory setting](#).

"Go to "Application wizard""

Note: Available for pumps with production code from 1838.

The "Application wizard" helps you choose the correct control mode for your application and includes the following:

- Boiler pump
- Radiator
- Fan coil unit
- Air handling unit
- Underfloor/ceiling
- Hot water
- Ground source
- Chiller pump.

You can exit the wizard by pressing the "Home" button .

You can also launch the wizard in the "Assist" menu. See section [8.8.1 "Application wizard"](#).

"External speed control"

Note: Available for pumps with production code from 1838.

When selecting the "External speed control", you can choose between the following:

- "0-10 V input" and "4-20 mA input"
Allows you to select either "Linear with Min." or "Linear with Stop. See also section [7.9.6 External setpoint function](#).
- "Bus controlled"
When selected and when the startup guide has completed, go to the "Settings" menu to configure the "Bus communication". See section [8.7.9 "Bus communication"](#).

8.4 Menu overview

"Home"	Status	"Settings"	"Assist"
Control mode	Operating status	Setpoint	Application wizard ¹⁾
Setpoint	Operating mode, from	Operating mode	Boiler pump
Estimated flow	Control mode	Normal	Radiator
Low flow ^{1), 2)}	Pump performance	Stop	Fan coil unit
Head	Max. curve and duty point	Min.	Air handling unit
	Resulting setpoint	Max.	Underfloor/ceiling
	Temperature	Control mode	Hot water
	Speed	AUTO _{ADAPT}	Ground source
	Operating hours	FLOW _{ADAPT}	Chiller pump
	Power and energy consumption	Prop. press.	Setting of date and time
	Power consumption	Const. press.	Date format, date and time
	Energy consumpt.	Const. temp.	Date only
	Warning and alarm	Diff. temp.	Time only
	Actual warning or alarm	Constant flow ¹⁾	Multipump setup
	Warning log	Constant curve	Setup, analog input
	Warning log 1 to 5	Controller settings (not model A)	Description of control mode
	Alarm log	Controller gain Kp	AUTO _{ADAPT}
	Alarm log 1 to 5	Control. integr. action time Ti	FLOW _{ADAPT}
	Heat energy monitor	Temperature sensor offset ¹⁾	Prop. press.
	Heat power	FLOW _{LIMIT}	Const. press.
	Heat energy	Enable FLOWLIMIT function	Const. temp.
	Estimated flow	Not active	Differential temp.
	Volume	Active	Constant curve
	Hours counter	Set FLOWLIMIT	Assisted fault advice
	Temperature 1	Automatic Night Setback	Blocked pump
	Temperature 2	Not active	Pump communication fault
	Differential temp.	Active	Internal fault
	Accuracy of values	Analog Input	Internal sensor fault
	Estimated flow	Function of analog input	Forced pumping
	Volume	Not active	Undervoltage
	Operating log	Differential-pressure control	Overvoltage
	Operating hours	Constant-temperature control	High motor temperature
	Trend data	Differential-temperature control	External sensor fault
	Duty point over time	Heat energy monitor	High liquid temperature
	3D showing (Q, H, t)	External setpoint influence	Comm. fault, twin-head pump
	3D showing (Q, T, t)	Unit	
	3D showing (Q, P, t)	°C	
	3D showing (T, P, t)	°F	
	Fitted modules	Sensor range, min. value	
	Date and time	Sensor range, max. value	
	Date	Electrical signal	
	Time	0-10 V	
	Pump identification	4-20 mA	
	Multipump system	Relay outputs	
	Operating status	Relay output 1	
	Operating mode, from	Not active	
	Control mode	Ready	
	System performance	Alarm	
	Duty point	Operation	
	Resulting setpoint	Relay output 2	
	System identification	Not active	
	Power and energy consumption	Ready	
	Power consumption	Alarm	
	Energy consumpt.	Operation	
	Other pump, multipump system	Setpoint influence	
	Operating mode, from	External setpoint function	
	Speed	Not active	
	Operating hours	Linear with Min.	
	Pump identification	Linear with Stop ¹⁾	
	Power consumption	Temperature influence	

"Home"	Status	"Settings"	"Assist"
	Actual warning or alarm	Not active Active, Tmax. = 50 °C Active, Tmax. = 80 °C Bus communication Pump number Forced local mode Enable Disable Multipump profile selection Compatibility for models A, B, C Generic Grundfos profile Automatic General settings Language Set date and time Select date format Set date Select time format Set time Units SI or US units Customised units Differential pressure Head Level Flow rate Volume Temperature Differential temp. Electrical power Electrical energy Heat power Heat energy Enable/disable settings Enable Disable Alarm and warning settings Internal sensor fault (88) Enable Disable Internal fault (157) Enable Disable Delete history Delete operating log Delete heat energy data Delete energy consumption Define Home display Select Home display type List of data Graphical illustration Define Home display contents List of data Graphical illustration Display brightness Brightness Return to factory settings Run start-up guide	

1) Available for pumps with production code from 1838.

2) Activated when the pump experiences a flow below 10 %. See section [8.5.1 Low-flow indication](#).

8.5 "Home" menu



Undef-010

Navigation

"Home"

Press to go to the "Home" menu.

This menu offers the following (factory setting):

- Shortcut to "Control mode" settings
- Shortcut to "Setpoint" settings
- Estimated flow
- Head.

Navigate in the display with or , and change between the two shortcuts with or .

Display icons

Symbol	Description
	Automatic night setback function is enabled.
	Settings are locked. You cannot adjust settings from the display.
	The pump is in remote mode, for example from fieldbus.
	The multipump system is active.
	Master pump in a multipump system.
	Slave pump in a multipump system.
	Forced local mode is active. You cannot set the pump to remote mode, for example from fieldbus.

You can define the "Home" display. See section ["Define Home display"](#), page 47.

8.5.1 Low-flow indication

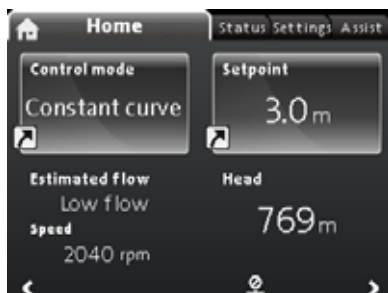

Home_LowFlow and Soeed

Note: Available for pumps with production code from 1838.

The pump can experience low flow due to for example valves being shut. In cases where the flow is below 10 %, thus too low for the pump's internal sensor to measure, it will be stated in the "Home" menu. The speed below the low-flow indication tells you that the pump is still running, but at a minimum curve.

When the flow is high enough for the pump to measure, the "Home" display will return back to normal.

8.6 "Status" menu

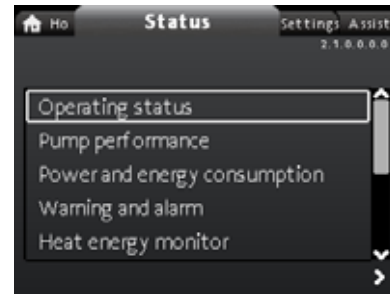

2.1.0.0.0 Status

Navigation

"Home" > "Status"

Press and go to the "Status" menu with .

This menu offers status information on the following:

- Operating status
- Pump performance
- Power and energy consumption
- Warning and alarm
- Heat energy monitor
- Operating log
- Fitted modules
- Date and time
- Pump identification
- Multipump system.



Data is stored once per hour. If the pump is turned off and on via the power supply more frequently than that, the data will be incorrect.

If you need to start and stop the pump more than once per hour, we recommend that you use the operating modes "Stop" and "Normal".

Navigation

1. Navigate between the submenus with or .
2. Choose a submenu with [OK] or .
3. Return to the Status menu with .

Detailed information on "Heat energy monitor" is available in the following section [8.6.1 "Heat energy monitor"](#).



2.1.1.0.0 Operating mode

Fig. 58 Example of the submenu "Operating status" showing the pump running in normal operation in a multipump system.

8.6.1 "Heat energy monitor"

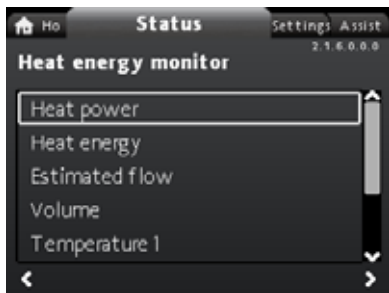

2.1.6.0.0.0.a - Status_HeatEnergyMonitor

Navigation

"Home" > Status > "Heat energy monitor"

The "Heat energy monitor" calculates the heat energy consumption within a system. For detailed information, see section [7.9.5 Heat energy monitor](#).

Learn how to set an input temperature sensor for monitoring heat energy in section [8.8.4 "Setup, analog input"](#).

The following submenus are explored in the following:

- Heat energy
- Estimated flow
- Accuracy of values.

"Heat energy"



2.1.6.2.0.0 Heat energy

Navigation

"Home" > Status > "Heat energy monitor" > "Heat energy"

You can measure both heating and cooling in the same system. If a system is used for both heating and cooling, two counters are automatically shown in the display.

The time stamp of the date indicates the latest use of the specific counter.

The value of "Latest year (2):" represents the last 52 consecutive weeks where the pump has been supplied with power. The user can reset the value manually. See section ["Delete history"](#), page [47](#).

"Estimated flow rate, accuracy"

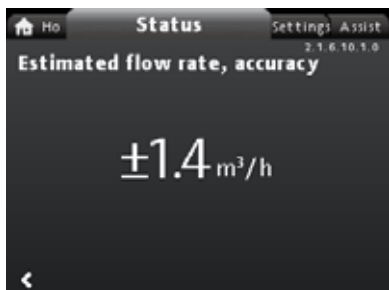

2.1.6.10.1.0 - Status_HeatEnergyMonitor_Accuracy_Estimated...

Navigation

"Home" > Status > "Heat energy monitor" > "Estimated flow"

The internal sensor estimates the difference in pressure between the inlet and outlet ports of the pump. The measurement is not a direct differential-pressure measurement, but by knowing the hydraulic design of the pump, you can estimate the differential pressure across the pump.

For further information, see section [7.6 Flow estimation accuracy](#).

"Accuracy of values"

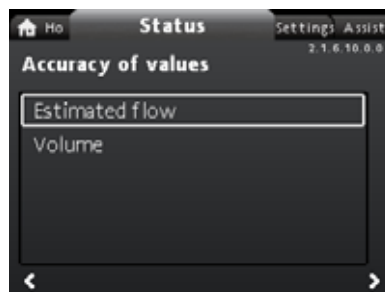

2.1.6.10.0.0 - Status_HeatEnergyMonitor_Accuracy

Navigation

"Home" > Status > "Heat energy monitor" > "Accuracy of values"

This menu offers the following options:

- Estimated flow
- Volume.

Select submenu with \downarrow or \uparrow .

This menu allows you to view the current flow rate tolerance and the average volume accuracy over the last 52 consecutive weeks ("Latest year:") and the pump's entire life span.

8.7 "Settings" menu

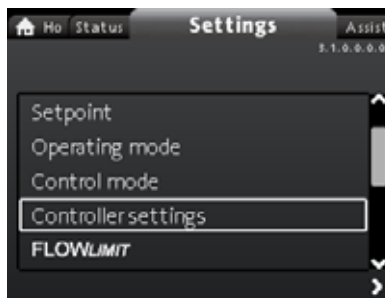

Settings

Navigation

"Home" > "Settings"

Press Ⓜ and go to the "Settings" menu with \rightarrow .

This menu offers the following options:

- Setpoint
- Operating mode
- Control mode
- Controller settings, not model A
- FLOW_{LIMIT}
- Automatic Night Setback
- Analog Input
- Relay outputs
- Setpoint influence
- Bus communication
- General settings.

Navigate between the submenus with \downarrow or \uparrow .

8.7.1 "Setpoint"

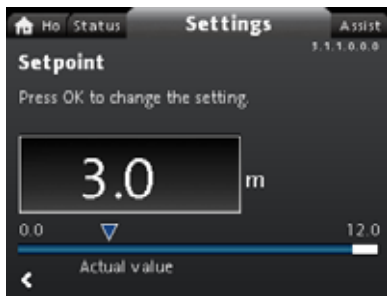

3.1.1.0.0.0 Setpoint

Navigation

"Home" > "Settings" > "Setpoint"

Setting

1. Press [OK].
2. Select digit with \leftarrow and \rightarrow and adjust with ∇ or \blacktriangle .
3. Press [OK] to save.

You can set the setpoint with an accuracy of 0.1 metre. The head against a closed valve is the setpoint.

Set the setpoint so that it matches the system. A too high setting may result in noise in the system whereas a too low setting may result in insufficient heating or cooling in the system.

Control mode	Measuring unit
Proportional pressure	m, ft
Constant pressure	m, ft
Constant temperature	°C, °F, K
Constant curve	%

8.7.2 "Operating mode"

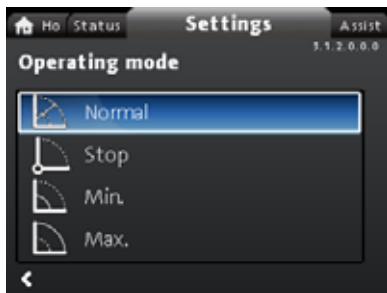

3.1.2.0.0.0 Operating mode

Navigation

"Home" > "Settings" > "Operating mode"

This menu offers the following options:

- Normal
- Stop
- Min.
- Max.

Setting

1. Select operating mode with ∇ or \blacktriangle .
2. Press [OK] to save.

For detailed information about the operating modes, see section [7.2 Operating modes](#).

8.7.3 "Control mode"

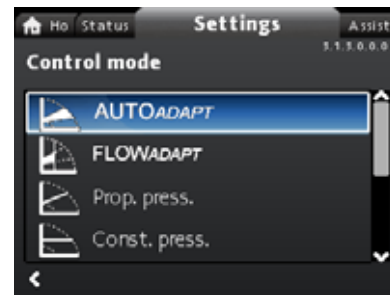

3.1.3.0.0.0 Control mode

Navigation

"Home" > "Settings" > "Control mode"



Set the operating mode to "Normal" before you enable a control mode.

This menu offers the following setting options:

- AUTO_{ADAPT} (the pump starts with the factory setting)
- FLOW_{ADAPT}
- Prop. press. (proportional pressure)
- Const. press. (constant pressure)
- Const. temp. (constant temperature)
- Differential temp. (differential temperature)
- Constant flow (available for pumps with production code from 1838)
- Constant curve.

Setting

1. Select control mode with ∇ or \blacktriangle .
2. Press [OK] to enable the control mode.

For details on the different control modes, see section [7.3 Control modes](#).

Setpoint

When you have selected the desired control mode, you can change the setpoint for all control modes, except AUTO_{ADAPT} and FLOW_{ADAPT}, in the "Setpoint" submenu. See section [8.7.1 "Setpoint"](#).

Control mode features

You can combine all control modes, except "Constant curve", with automatic night setback. See section ["Automatic Night Setback"](#).

You can also combine the FLOW_{LIMIT} function with the last five control modes mentioned above. See section [8.7.5 "FLOWLIMIT"](#).

8.7.4 "Controller settings"



Controller_setting_menu_with_temperature_offset

Not available for MAGNA3 model A.

Navigation

"Home" > "Settings" > "Controller settings"

This menu offers the following options:

- Controller gain Kp
- Control. integr. action time Ti
- Temperature sensor offset (available for pumps with production code from 1838).

Setting

1. Select "Controller settings" with \downarrow or \uparrow and press [OK].
2. Choose either "Controller gain Kp", "Control. integr. action time Ti" or "Temperature sensor offset" with \downarrow or \uparrow . Press [OK].
3. Press [OK] to start the setting.
4. Select digit with \leftarrow and \rightarrow and adjust with \downarrow or \uparrow .
5. Press [OK] to save.

A change of the gain and integral-time values affects all control modes. If you change the control mode to another control mode, change the gain and integral-time values to the factory settings.

Factory settings for all other control modes:

The gain, K_p , is equal to 1.

The integral time, T_i , is equal to 8.

The table below shows the suggested controller settings:

If you use a built-in temperature sensor as one of the sensors, you must install the pump as close as possible to the consumer.

System/ application	K_p		T_i
	Heating system ¹⁾	Cooling system ²⁾	
	0.5	- 0.5	10 + 5 ($L_1 + L_2$)
	- 0.5		10 + 5 ($L_1 + L_2$)
	0.5	- 0.5	30 + 5 L_2

1) In heating systems, an increase in pump performance results in a rise in temperature at the sensor.

2) In cooling systems, an increase in pump performance results in a drop in temperature at the sensor.

3) Built-in temperature sensor.

L1: Distance in metres between pump and consumer.

L2: Distance in metres between consumer and sensor.

Guidelines for setting of PI controller

For most applications, the factory setting of the controller constants, gain and integral time, ensures optimum pump operation. However, in some applications an adjustment of the controller may be required.

You find the setpoint displayed in figs 59 and 60.



Fig. 59 "Controller gain Kp"

undef-079

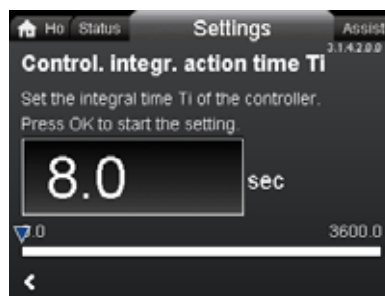

Fig. 60 "Control. integr. action time Ti"

undef-080

Proceed as follows:

1. Increase the gain until the motor becomes unstable. Instability can be seen by observing if the measured value starts to fluctuate. Furthermore, instability is audible as the motor starts hunting up and down. Some systems, such as temperature controls, are slow-reacting, meaning that it may be several minutes before the motor becomes unstable.
2. Set the gain to half the value of the value which made the motor unstable.
3. Reduce the integral time until the motor becomes unstable.
4. Set the integral time to twice the value which made the motor unstable.

Rules of thumb

If the controller is too slow-reacting, increase the gain.

If the controller is hunting or unstable, dampen the system by reducing the gain or increasing the integral time.

Model A:

Use Grundfos GO to change the controller constants, gain and integral time. You can only set positive values.

Models B, C and D:

Change the control settings by means of the display or Grundfos GO. You can set both positive and negative values.

8.7.5 "FLOWLIMIT"



3.1.5.0.0.0 FLOWLIMIT

Navigation

"Home" > "Settings" > "FLOWLIMIT"

This menu offers the following options:

- Enable FLOWLIMIT function
- Set FLOWLIMIT.

Setting

1. To enable the function, select "Enable FLOWLIMIT function" with \downarrow or \uparrow and press [OK].
2. To set the FLOW_{LIMIT}, press [OK].
3. Select digit with \leftarrow and \rightarrow and adjust with \downarrow or \uparrow .
4. Press [OK] to save.

You can combine the FLOW_{LIMIT} function with the following control modes:

- Prop. press.
- Const. press.
- Const. temp.
- Constant curve.

For more information about FLOW_{LIMIT}, see section [7.4.1 FLOW_{LIMIT}](#).

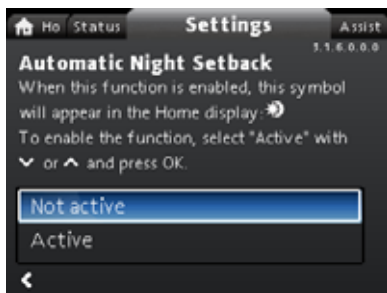
"Automatic Night Setback"

3.1.6.0.0.0 Automatic Night Setback

Navigation

"Home" > "Settings" > "Automatic Night Setback"

Setting

To enable the function, select "Active" with \downarrow or \uparrow and press [OK].

For more information about Automatic Night Setback, see section [7.4.2 Automatic night setback](#).

8.7.6 "Analog Input"

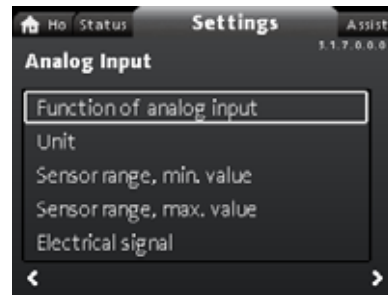

3.1.7.0.0.0 Analog input

Navigation

"Home" > "Settings" > "Analog Input"

This menu offers the following options:

- Function of analog input
- Unit
- Sensor range, min. value
- Sensor range, max. value
- Electrical signal.

Setting

1. Choose "Function of analog input" with \downarrow or \uparrow and press [OK].
2. Choose the function of input with \downarrow or \uparrow :
 - Not active
 - Differential-pressure control
 - Constant-temperature control
 - Differential-temperature control
 - Heat energy monitor
 - External setpoint influence
3. Press [OK] to enable the function mode.

When you have selected the desired function, specify the sensor parameters:

4. Return to the "Analog Input" menu with \leftarrow .
5. Now adjust the sensor parameters "Unit", "Sensor range, min. value", "Sensor range, max. value" and "Electrical signal".
6. Choose the desired parameter with \downarrow or \uparrow and press [OK].
7. Select value or adjust digits with \downarrow or \uparrow and press [OK].
8. Return to the "Analog Input" menu with \leftarrow .

Note: You can also use the "Assist" menu to set the analog input. Here a wizard guides you through each step of the configuration. See section [8.8.4 "Setup, analog input"](#).

For more information on "Analog Input", see section [7.9.4 Analog input](#).

For further information on "Heat energy monitor" see section [7.9.5 Heat energy monitor](#).

8.7.7 "Relay outputs"

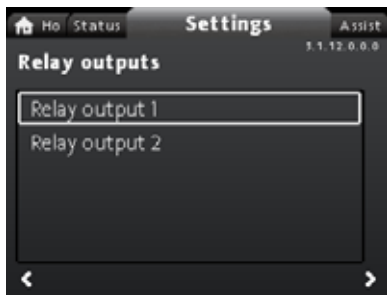

3.1.12.0.0.0 Relay outputs

Navigation

"Home" > "Settings" > "Relay outputs"

This menu offers the following options:

- Relay output 1
- Relay output 2.

Setting

1. Choose "Relay output 1" with \downarrow or \uparrow and press [OK].
2. Choose the function of input with \downarrow or \uparrow :
 - "Not active": The signal relay is deactivated.
 - "Ready": The signal relay is active when the pump is running or has been set to stop, but is ready to run.
 - "Alarm": The signal relay is activated together with the red indicator light on the pump.
 - "Operation": The signal relay is activated together with the green indicator light on the pump.
3. Press [OK] to save.

Repeat steps 1-3 for "Relay output 2".

For detailed information on "Relay outputs", see section [7.9.2 Relay outputs](#).

The duty ranges for proportional-pressure and constant-pressure control appear from the data sheets in the [MAGNA3 data booklet](#).

In constant-curve duty, you can control the pump from minimum to 100 %. The range of control depends on the minimum speed, power and pressure limits of the pump.

8.7.8 "Setpoint influence"

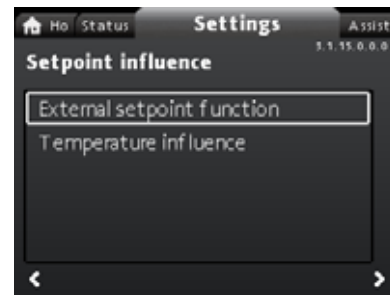

3.1.15.0.0.0 Setpoint influence

Navigation

"Home" > "Settings" > "Setpoint influence"

This menu offers the following options:

- External setpoint function
- Temperature influence.

"External setpoint function"

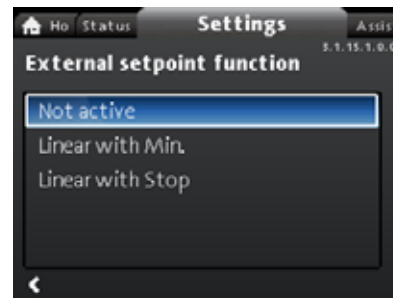

External_Setpoint_Function

Navigation

"Home" > "Settings" > "Setpoint influence" > "External setpoint function"

Setting

1. Select "Linear with Min." or "Linear with Stop" (available for pumps with production code from 1838) with \downarrow or \uparrow and press [OK].

Note: The analog input must be set to "External setpoint influence" before the "External setpoint function" can be enabled. If the analog input is set to external setpoint influence, the external setpoint function is automatically activated with "Linear with Min.". See section [7.9.4 Analog input](#).

For detailed information on "External setpoint function", see section [7.9.6 External setpoint function](#).

"Temperature influence"

Navigation

"Home" > "Settings" > "Setpoint influence" > "Temperature influence"

This menu offers the following options:

- Not active
- Active, T_{max.} = 50 °C
- Active, T_{max.} = 80 °C.

Setting

1. Select "Temperature influence" with \blacktriangledown or \blacktriangle and press [OK].
2. Choose the desired maximum temperature with \blacktriangledown or \blacktriangle and press [OK].

When this function is enabled in proportional- or constant-pressure control mode, the setpoint for head is reduced according to the liquid temperature.

You can set the temperature influence to function at liquid temperatures below 80 or 50 °C. These temperature limits are called T_{\max} . The setpoint is reduced in relation to the head set which is equal to 100 %, according to the characteristics below.

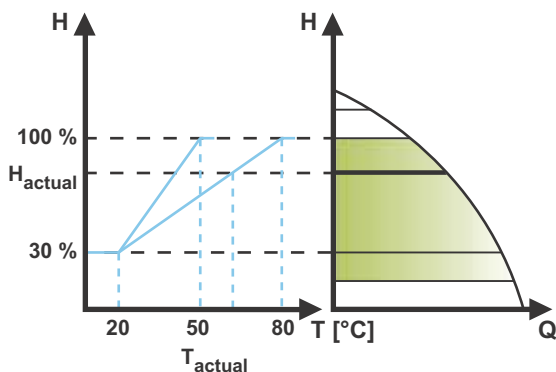

TM05 3022 1212

Fig. 61 "Temperature influence"

In the above example, T_{\max} , which is equal to 80 °C, has been selected. The actual liquid temperature, T_{actual} , causes the setpoint for head to be reduced from 100 % to H_{actual} .

Requirements

The temperature influence function requires the following:

- proportional-pressure, constant-pressure or constant-curve control mode
- pump installed in flow pipe
- system with flow-pipe temperature control.

Temperature influence is suitable for the following systems:

- Systems with variable flows for example two-pipe heating systems, in which the enabling of the temperature influence function ensures a further reduction of the pump performance in periods with small heating demands and consequently a reduced flow-pipe temperature.
- Systems with almost constant flows, for example one-pipe heating systems and underfloor heating systems, in which variable heating demands cannot be registered as changes in the head as is the case with two-pipe heating systems. In such systems, you can only adjust the pump performance by enabling the temperature influence function.

Selection of maximum temperature

In systems with a dimensioned flow-pipe temperature:

- Up to and including 55 °C, select a maximum temperature equal to 50 °C.
- Above 55 °C, select a maximum temperature equal to 80 °C.

You cannot use the temperature influence function in air-conditioning and cooling systems.

8.7.9 "Bus communication"

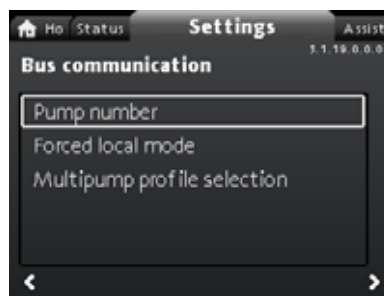

Navigation

"Home" > "Settings" > "Bus communication"

This menu offers the following options:

- Pump number
- Forced local mode
- Multipump profile selection

"Pump number"

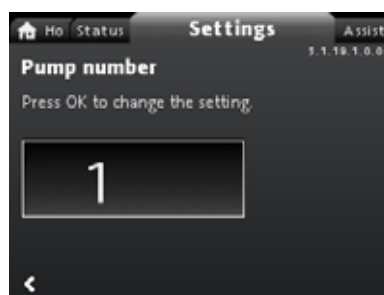

Navigation

"Home" > "Settings" > "Bus communication" > "Pump number"

Setting

1. Press "OK" to start the setting. The pump allocates a unique number to the pump.

The unique number enables you to distinguish between the pumps in connection with bus communication.

"Forced local mode"

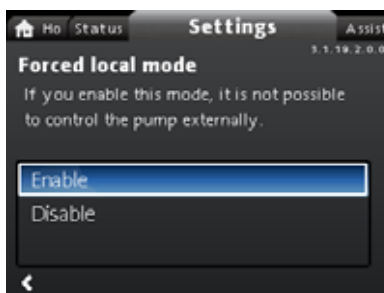

Navigation

"Home" > "Settings" > "Bus communication" > "Forced local mode"

Setting

To enable the function, choose "Enable" with \blacktriangledown or \blacktriangle and press [OK]. To disable the function, choose "Disable" with \blacktriangledown or \blacktriangle and press [OK].

You can temporarily override remote commands from a building management systems to make local settings. Once you have disabled "Forced local mode", the pump reconnects to the network when it receives a remote command from the building management system.

"Multipump profile selection"

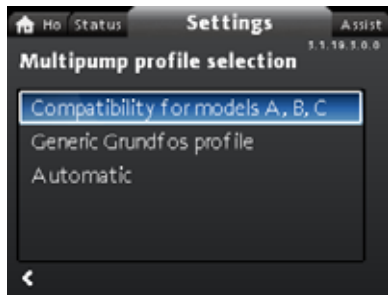

3.1.19.3.0.0 - Settings_BusCommunication_Multi...

Navigation

"Home" > "Settings" > "Bus communication" > "Multipump profile selection"

This menu offers the following options:

- Compatibility for models A, B, C
- Generic Grundfos profile
- Automatic.

Setting

Select mode with \downarrow and \uparrow and press [OK].

All settings must be done from the master pump.

The MAGNA3 model D pump is able to automatically detect and adjust itself to an existing system with older version pumps or an older BMS. You enable this function by choosing "Automatic" in the display.

"Generic Grundfos profile" overrules auto detection, and the pump runs as a model D. However, if your BMS system or existing pumps are older versions, we recommend that you choose either "Automatic" or "Compatibility for models A, B, C".

See section [11.2.4 Auto detection of CIM modules](#) for further information on auto detection.

8.7.10 "General settings"

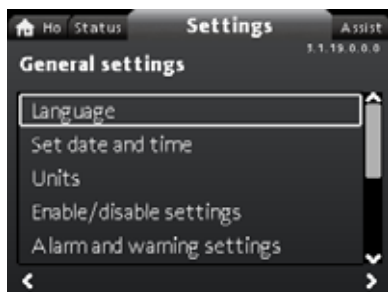

3.1.19.0.0.0.a - Settings_GenSettings

Navigation

"Home" > "Settings" > "General settings"

This menu offers the following options:

- Language
- Set date and time
- Units
- Enable/disable settings
- Alarm and warning settings
- Delete history
- Define Home display
- Display brightness
- Return to factory settings
- Run start-up guide.

"Language"

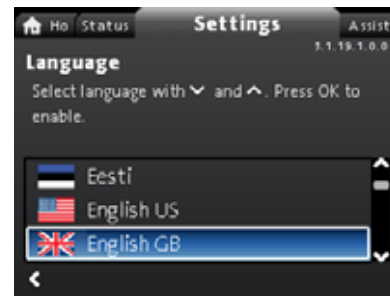

3.1.19.1.0.0 Language

Navigation

"Home" > "Settings" > "General settings" > "Language"

Setting

1. Select language with \downarrow and \uparrow .
2. Press [OK] to enable the language.

The display can be shown in any of the following languages:

- Bulgarian
- Croatian
- Czech
- Danish
- Dutch
- English
- Estonian
- Finnish
- French
- German
- Greek
- Hungarian
- Italian
- Japanese
- Korean
- Latvian
- Lithuanian
- Polish
- Portuguese
- Romanian
- Russian
- Serbian
- Simplified Chinese
- Slovak
- Slovenian
- Spanish
- Swedish
- Turkish
- Ukrainian.

Measuring units are automatically changed according to the selected language.

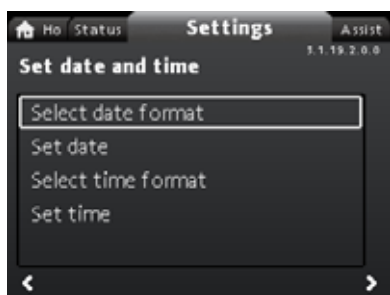
"Set date and time"

3.1.19.2.0.0 Set date and time

Navigation

"Home" > "Settings" > "General settings" > "Set date and time"

This menu offers the following options:

- Select date format
- Set date
- Select time format
- Set time.

Setting the date

1. Choose "Select date format" with \downarrow or \uparrow and press [OK]. Choose either "YYYY-MM-DD", "DD-MM-YYYY" or "MM-DD-YYYY".
2. Press \leftarrow to return to "Set date and time".
3. Select "Set date" with \downarrow or \uparrow and press [OK].
4. Select digit with \leftarrow and \rightarrow and adjust with \downarrow or \uparrow .
5. Press [OK] to save.

Setting the time

1. Choose "Select time format" with \downarrow or \uparrow and press [OK]. Choose either "HH:MM 24-hour clock" or "HH:MM am/pm 12-hour clock".
2. Press \leftarrow to return to "Set date and time".
3. Select "Set time" with \downarrow or \uparrow and press [OK].
4. Select digit with \leftarrow and \rightarrow and adjust with \downarrow or \uparrow .
5. Press [OK] to save.

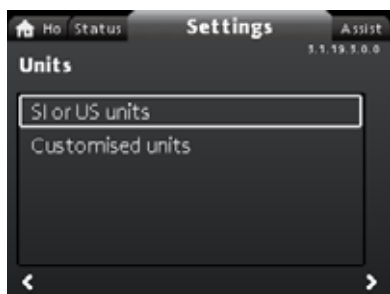
"Units"

3.1.19.3.0.0 Units

Navigation

"Home" > "Settings" > "General settings" > "Units"

This menu offers the following:

- SI or US units
- Customised units.

In this menu you can select between SI and US units. The setting can be made generally for all parameters or customised for each individual parameter:

- Pressure
- Differential pressure
- Head
- Level
- Flow rate
- Volume
- Temperature
- Differential temp.
- Power
- Energy.

Setting, general

1. Select "SI or US units" with \downarrow or \uparrow and press [OK].
2. Choose either SI or US units with \downarrow or \uparrow and press [OK].

Setting, customised

1. Select "Customised units" with \downarrow or \uparrow and press [OK].
2. Select parameter and press [OK].
3. Select unit with \downarrow or \uparrow . Press [OK].
4. Return to parameters with \leftarrow . Repeat steps 2-4 if necessary.

If you have selected SI or US units, the customised units are reset.

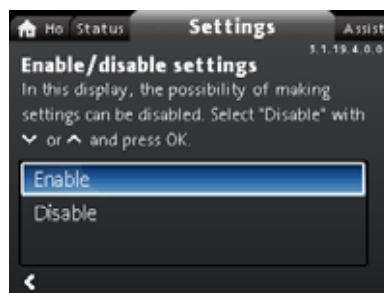
"Enable/disable settings"

3.1.19.4.0.0 Enable/disable settings

Navigation

"Home" > "Settings" > "General settings" > "Enable/disable settings"

Setting

5. Select "Disable" with \downarrow or \uparrow and press [OK]. The pump is now locked for settings. Only the "Home" display is available.

In this display, you can disable the possibility of making settings. To unlock the pump and allow settings, press \downarrow and \uparrow simultaneously for at least 5 seconds or enable the settings again in the menu.

"Alarm and warning settings"

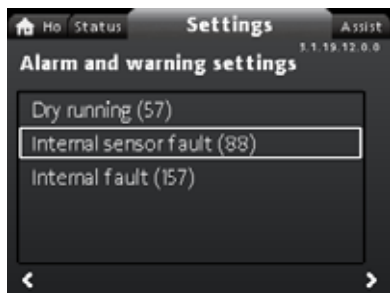

3.1.19.12.0.0 - Settings_GenSettings_Alarm...

Navigation

"Home" > "Settings" > "General settings" > "Alarm and warning settings"

This menu offers the following:

- Dry running (57)
- Internal sensor fault (88)
- Internal fault (157).

"Internal sensor fault (88)"

Navigation

"Home" > "Settings" > "General settings" > "Internal sensor fault (88)"

Setting

1. Select either "Enable" or "Disable" with \blacktriangledown or \blacktriangleup and press [OK].

In case of a sensor problem related to the quality of the liquid, the pump is able to continue operation with satisfactory performance in most situations. In such situations, you can disable "Internal sensor fault (88)".

"Internal fault (157)"

Navigation

"Home" > "Settings" > "General settings" > "Internal fault (157)"

Setting

1. Select either "Enable" or "Disable" with \blacktriangledown or \blacktriangleup and press [OK].

If the real-time clock is out of order, for example due to a dead battery, a warning is shown. You can disable the warning.

"Delete history"

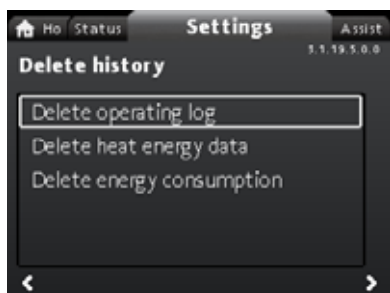

3.1.19.5.0.0 Delete history

Navigation

"Home" > "Settings" > "General settings" > "Delete history"

This menu offers the following:

- Delete operating log
- Delete heat energy data
- Delete energy consumption.

Setting

1. Select submenu with \blacktriangleleft or \blacktriangleright and press [OK].
2. Select "Yes" with \blacktriangledown or \blacktriangleup and press [OK] or press \odot to cancel.

You can delete data from the pump, for example if the pump is moved to another system or if new data are required due to changes to the system.

"Define Home display"

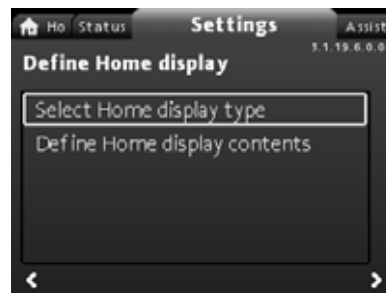

3.1.19.6.0.0 Define Home display

Navigation

"Home" > "Settings" > "General settings" > "Define Home display"

This menu offers the following:

- Select Home display type
 - List of data
 - Graphical illustration
- Define Home display contents.
 - List of data.

In this menu, you can set the "Home" display to show up to four user-set parameters or a graphical illustration of a performance curve.

Setting: "Select Home display type"

1. Choose "Select Home display type" with \blacktriangledown or \blacktriangleup and press [OK].
 2. Select "List of data" with \blacktriangledown or \blacktriangleup . Press [OK].
 3. A list of parameters appears in the display. Select or deselect with [OK].
 4. Return to "Select Home display type" with \blacktriangleleft .
 5. Select "Graphical illustration" with \blacktriangledown or \blacktriangleup and press [OK].
 6. Select the desired curve. Press [OK] to save.
- To specify the contents, go to "Define Home display contents".

Setting: "Define Home display contents"

1. Choose "Define Home display contents" with \blacktriangledown or \blacktriangleup and press [OK].
2. To set "List of data" with \blacktriangledown or \blacktriangleup . Press [OK].
3. A list of parameters appears in the display. Select or deselect with [OK].

The selected parameters are now visible in the "Home" menu. See fig. 62. The arrow indicates that the parameter links to the "Settings" menu and works as a shortcut for quick settings.

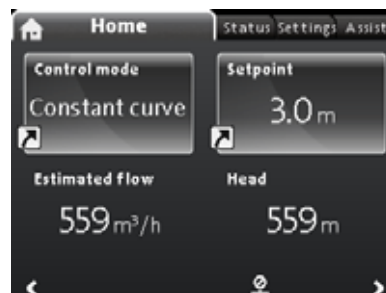

Define Home display contents

Fig. 62 Example: "Home" menu parameters

"Display brightness"

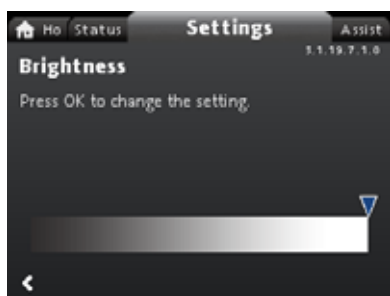

3.1.19.7.1.0 Brightness

Navigation

"Home" > "Settings" > "General settings" > "Display brightness"

Setting

1. Press [OK].
2. Set brightness with ◀ and ▶.
3. Press [OK] to save.

"Return to factory settings"

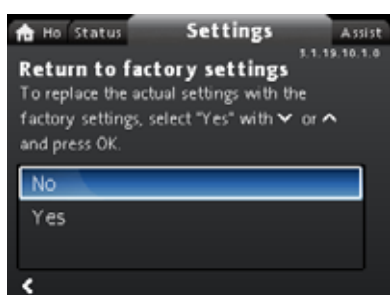

3.1.19.10.1.0 Return to factory settings

Navigation

"Home" > "Settings" > "General settings" > "Return to factory settings"

Setting

To overwrite the current settings with the factory settings, select "Yes" with ▼ or ▲ and press [OK].

You can recall the factory settings and overwrite the current settings. All user settings in the "Settings" and "Assist" menus are set back to the factory settings. This also includes language, units, setup of analog input, multipump function, etc.

"Run start-up guide"

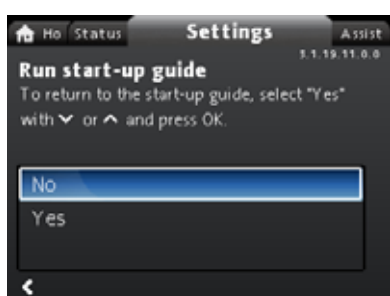

3.1.19.11.0.0 Run start-up guide

Navigation

"Home" > "Settings" > "General settings" > "Run start-up guide"

Setting

To run the startup guide, select "Yes" with ▼ or ▲ and press [OK].

The startup guide automatically starts when you start the pump for the first time; however, you can always run the startup guide later via this menu.

The startup guide guides you through the general settings of the pump, such as language, date and time.

8.8 "Assist" menu

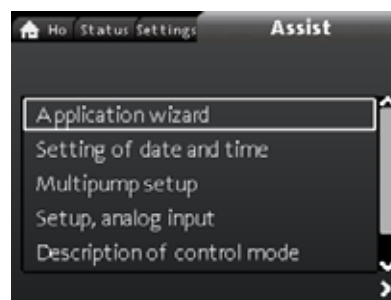

Assist_menu_With_Application_Wizard

Navigation

"Home" > "Assist"

Press Ⓜ and go to the "Assist" menu with ▶.

The menu guides you through and offers the following:

- Application wizard (available for pumps with production code from 1838)
- Setting of date and time
- Multipump setup
- Setup, analog input
- Description of control mode
- Assisted fault advice.

The "Assist" menu guides the user through the setting of the pump. In each submenu, there is a guide that guides the user through the setting of the pump.

8.8.1 "Application wizard"

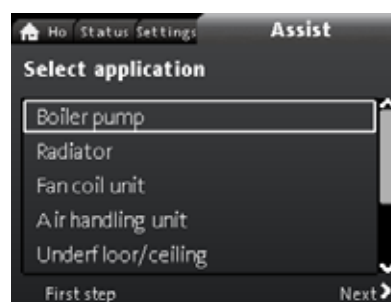

Assist_Application_Wizard_Main_Menu

Available for pumps with production code from 1838.

Navigation

"Home" > "Assist" > "Application wizard"

This menu guides you through a complete pump setup and helps you set the correct control mode.

Applications available in this menu:

- Boiler pump
- Radiator
- Fan coil unit
- Air handling unit
- Underfloor/ceiling
- Hot water
- Ground source
- Chiller pump.

Setting

1. Choose the system that applies to the function of your pump with ▼ or ▲ and press [OK] followed by ▶.
2. Select the characteristics applicable to your system with ▼ or ▲ and press [OK] followed by ▶.
3. Continue this process until the setup has been completed.

If you wish to change the selected control mode, either launch the "Application wizard" again or choose a control mode in the "Settings" menu. See section [8.7.3 "Control mode"](#).

8.8.2 "Setting of date and time"

Navigation

"Home" > "Assist" > "Setting of date and time"

This menu guides you through the setup of time and date. See also section ["Set date and time"](#).

8.8.3 "Multipump setup"

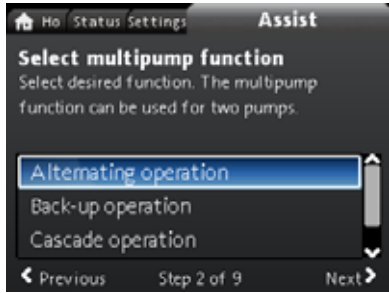

Undef-083 Select multi pump function

Navigation

"Home" > "Assist" > "Multipump setup"

This menu offers the following:

- Alternating operation
- Back-up operation
- Cascade operation
- No multipump function.

Setting: "Alternating operation", "Back-up operation" and "Cascade operation"

1. Select the desired operating mode with ∇ or \blacktriangle and press [OK].
2. Follow the step-by-step guide to complete the multipump setup.
3. Check the entered values.
4. Press [OK] to confirm and enable the settings.

You can set a multipump system from a selected pump, which will then be the master pump. Check the display to identify the master pump in a multipump system. See fig. 63 and section [Display icons](#), page 38.

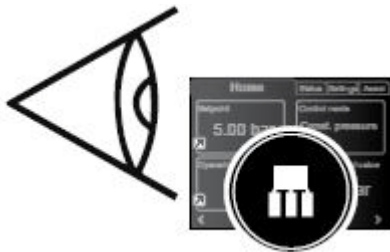

Fig. 63 Identify the master pump in a multipump system

A twin-head pump is set to multipump function from factory. Here pump head I is defined as master pump. Check the nameplate to identify the master pump. See fig. 64.

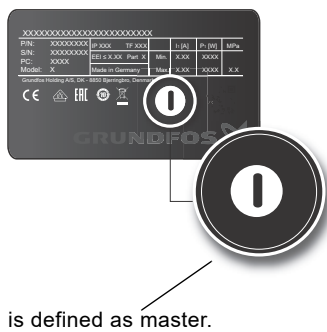

Fig. 64 Identify the master pump on a twin-head pump

For detailed information on the control modes, see section [7.5 Multipump modes](#).

Setting: "No multipump function"

1. Select the "No multipump function" with ∇ or \blacktriangle and press [OK].
2. The pumps run as single-head pumps.

8.8.4 "Setup, analog input"

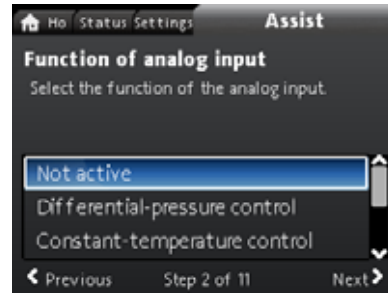

Heat energy monitor

Navigation

"Home" > "Assist" > "Setup, analog input"

Setting, example: "Analog Input" > "Heat energy monitor"

1. To enable the sensor input, select "Heat energy monitor" with ∇ or \blacktriangle and press [OK].
2. Follow the step-by-step guide to complete the sensor-input setup. Start with selecting the unit of the sensor, see fig. 65, and end with the summary display.
3. Check the entered values.
4. Press [OK] to confirm and enable the settings.

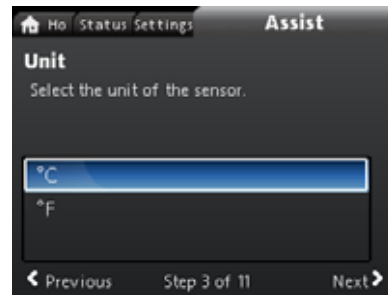

undef-147

Fig. 65 Unit display

Learn more about "Heat energy monitor" in section [7.9.5 Heat energy monitor](#) and "Heat energy" in ["Heat energy"](#), page 39.

8.9 "Description of control mode"

Navigation

"Home" > "Assist" > "Description of control mode"

This menu describes the possible control modes.

8.10 "Assisted fault advice"

Navigation

"Home" > "Assist" > "Assisted fault advice"

This menu gives guidance and corrective actions in case of pump failures.

TM06 7499 3516

TM06 6890 2516

9. Servicing the product

Before dismantling

WARNING

Electric shock

Death or serious personal injury

- Make sure that other pumps or sources do not force flow through the pump even if the pump is stopped. This will cause the motor to act like a generator, resulting in voltage on the pump.



WARNING

Electric shock

Death or serious personal injury

- Switch off the power supply for at least 3 minutes before you start any work on the product.
- Lock the main switch in position 0. Type and requirements as specified in EN 60204-1, 5.3.2.



WARNING

Magnetic field

Death or serious personal injury

- Persons with pacemakers disassembling this product must exercise care when handling the magnetic materials embedded in the rotor.



9.1 Differential-pressure and temperature sensor

The pump incorporates a differential-pressure and temperature sensor. The sensor is located in the pump housing in a channel between the inlet and outlet ports. The sensors of twin-head pumps are connected to the same channel and the pumps therefore register the same differential pressure and temperature.

Via a cable, the sensor sends an electrical signal for the differential pressure across the pump and for the liquid temperature to the controller in the control box.

If the sensor fails, the pump continues using the last measurement from the sensor and operate based on this. In earlier software versions, model A, the pump runs at maximum speed in case of a sensor fault.

When the fault has been corrected, the pump continues operating according to the parameters set.

The differential-pressure and temperature sensor offers substantial benefits:



- direct feedback on the pump display
- complete pump control
- measurement of the pump load for precise and optimum control resulting in higher energy efficiency.

9.2 External sensor condition

In case of missing sensor signal:

- Pumps produced before week 4, 2016: The pump runs at maximum speed.
- Pumps produced after week 4, 2016: The pump runs at 50 % of the nominal speed.

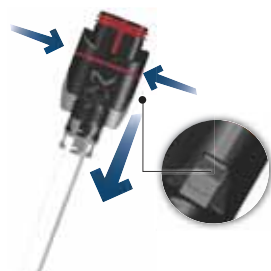
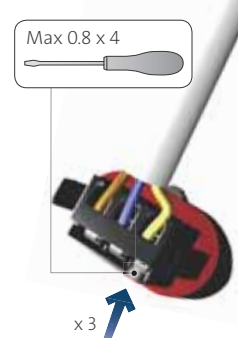
9.3 Disassembling the plug

Step	Action	Illustration
1	Loosen the cable gland and remove it from the plug.	
2	Pull off the plug cover while pressing on both sides.	
3	Loosen the cable conductors one by one by pressing a screwdriver gently into the terminal clip.	
4	The plug has now been removed from the power supply plug.	

TM05 5545 3812







TM05 5546 3812

TM05 5547 3812

TM05 5548 3812



10. Fault finding the product

10.1 Grundfos Eye operating indications

Grundfos Eye	Indication	Cause
	No lights are on.	The power is off. The pump is not running.
	Two opposite green indicator lights running in the direction of rotation of the pump.	The power is on. The pump is running.
	Two opposite green indicator lights are permanently on.	The power is on. The pump is not running.
	One yellow indicator light running in the direction of rotation of the pump.	Warning. The pump is running.
	One yellow indicator light is permanently on.	Warning. The pump has stopped.
	Two opposite red indicator lights flashing simultaneously.	Alarm. The pump has stopped.
	One green indicator light in the middle is permanently on in addition to another indication.	Remote-controlled. The pump is currently being accessed by Grundfos GO.

Signals from Grundfos Eye

The operating condition of the pump is indicated by Grundfos Eye on the operating panel when it communicates with a remote control.

Indication	Description	Grundfos Eye
The green indicator light in the middle flashes quickly four times.	This is a feedback signal which the pump gives in order to ensure identification of itself.	
The green indicator light in the middle flashes continuously.	Grundfos GO or another pump is trying to communicate with the pump. Press [OK] on the pump operating panel to allow communication.	
The green indicator light in the middle is permanently on.	Remote control with Grundfos GO via radio. The pump is communicating with Grundfos GO via radio connection.	

10.2 Fault finding table

Warning and alarm codes	Fault	Automatic reset and restart	Remedy
"Pump communication fault" (10) "Alarm"	Communication fault between different parts of the electronics.	Yes	Contact Grundfos Service, or replace the pump. Check if the pump is running in turbine operation. See code (29) "Forced pumping".
"Forced pumping" (29) "Alarm"	Other pumps or sources force flow through the pump even if the pump is stopped and switched off.	Yes	Switch off the pump on the main switch. If the light in Grundfos Eye is on, the pump is running in forced-pumping mode. Check the system for defective non-return valves and replace the valves, if necessary. Check the system for correct position of non-return valves, etc.
"Undervoltage" (40, 75) "Alarm"	The supply voltage to the pump is too low.	Yes	Make sure that the power supply is within the specified range.
"Blocked pump" (51) "Alarm"	The pump is blocked.	Yes	Dismantle the pump, and remove any foreign matter or impurities preventing the pump from rotating.
"High motor temperature" (64) "Alarm"	The temperature in the stator windings is too high.	No	Contact Grundfos Service, or replace the pump.
"Internal fault" (72 and 155) "Alarm"	<ul style="list-style-type: none"> Internal fault in the pump electronics. Irregularities in the voltage supply can cause alarm 72. Overload of the 24 VDC output can cause alarm 72. See section Input and output communication. 	Yes	There might be turbine flow in the application that forces a flow through the pump. Check if the sensor is blocked by sediments. This can occur if the media is impure. Replace the pump, or contact Grundfos Service.
"Overvoltage" (74) "Alarm"	The supply voltage to the pump is too high.	Yes	Make sure that the power supply is within the specified range.
"Comm. fault, twin-head pump" (77) "Warning"	The communication between pump heads was disturbed or broken.	-	Make sure that the second pump head is powered on or connected to the power supply.
"Internal fault" (84, 85 and 157) "Warning"	Fault in the pump electronics.	-	Contact Grundfos Service, or replace the pump.
"Internal sensor fault" (88) "Warning"	The pump is receiving a signal from the internal sensor which is outside the normal range.	-	Make sure that the plug and cable are connected correctly in the sensor. The sensor is located on the back of the pump housing. Replace the sensor, or contact Grundfos Service.
"External sensor fault" (93) "Warning"	The pump is receiving a signal from the external sensor which is outside the normal range.	-	Does the electrical signal set (0-10 V or 4-20 mA) match the sensor output signal? If not, change the setting of the analog input, or replace the sensor with one that matches the setup. Check the sensor cable for damage. Check the cable connection at the pump and at the sensor. Correct the connection, if required. See section 9.1 Differential-pressure and temperature sensor . The sensor has been removed, but the analog input has not been disabled. Replace the sensor, or contact Grundfos Service.



Warnings do not activate the alarm relay.

10.3 Fault finding

Reset a fault indication in one of the following ways:

- When you have eliminated the fault cause, the pump reverts to normal duty.
- If the fault disappears by itself, the fault indication is automatically reset.

The fault cause is stored in the pump alarm log.

CAUTION

Pressurised system



Minor or moderate personal injury

- Before dismantling the pump, drain the system or close the isolating valve on either side of the pump. The pumped liquid may be scalding hot and under high pressure



If the power supply cable is damaged, it must be replaced by the manufacturer, the manufacturer's service partner or a similarly qualified person.

WARNING

Electric shock



Death or serious personal injury

- Switch off the power supply for at least 3 minutes before you start any work on the product. Lock the main switch in position 0. Type and requirements as specified in EN 60204-1, 5.3.2.

WARNING

Electric shock



Death or serious personal injury

- Make sure that other pumps or sources do not force flow through the pump even if the pump is stopped.

11. Accessories

11.1 Grundfos GO

The pump is designed for wireless radio or infrared communication with Grundfos GO. Grundfos GO enables setting of functions and gives access to status overviews, technical product information and actual operating parameters.



The radio communication between the pump and Grundfos GO is encrypted to protect against misuse.

Grundfos GO is available in Apple App Store and Google Play. Grundfos GO replaces the Grundfos R100 remote control. This means that all products supported by R100 are now supported by Grundfos GO.

You can use Grundfos GO for the following:

- Reading of operating data.
- Reading of warning and alarm indications.
- Setting of control mode.
- Setting of setpoint.
- Selection of external setpoint signal.
- Allocation of pump number to distinguish between pumps that are connected via GENIbus.
- Selection of function for digital input.
- Generation of reports in PDF.
- Assist function.
- Multipump setup.
- Display of relevant documentation.

For function and connection to the pump, see separate installation and operating instructions for the desired type of Grundfos GO setup.

11.2 Communication interface module, CIM

The pump can communicate via the wireless GENIair connection or a communication module.

This enables the pump to communicate with other pumps and with different types of network solutions.

The Grundfos communication interface modules enable the pump to connect to standard fieldbus networks.

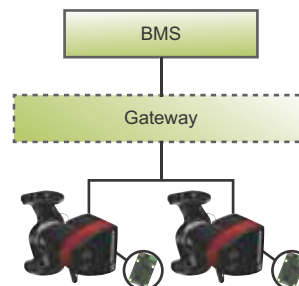

Fig. 66 Building management system, BMS, with two pumps connected in parallel

A communication interface module is an add-on communication interface module.

The communication interface module enables data transmission between the pump and an external system, for example a building management system or SCADA system.

The communication interface module communicates via fieldbus protocols.







A gateway is a device that facilitates the transfer of data between two different networks based on different communication protocols.



Pumps older than model C must have a CIM module mounted in both the slave and master pump. Pumps from model C have an integrated booster profile, which enables data in the slave to be monitored by the master. This booster profile supports newer versions of CIM modules, making it possible only to mount the CIM module on the master pump. The CIM modules supporting the booster profile are indicated in the overview below.

Available communication interface modules

Module	Fieldbus protocol	Product number	Booster profile compatible, from
CIM 050	GENIbus	96824631	
CIM 100	LonWorks	96824797	V03.03.00
CIM 150	PROFIBUS DP	96824793	V08.07.00
CIM 200	Modbus RTU	96824796	V09.16.00
CIM 250	GSM/GPRS	96824795	V07.04.00
CIM 270	GRM	96898815	V04.11.00
CIM 300	BACnet MS/TP	96893770	V04.12.00
CIM 500	Ethernet	98301408	V05.04.00

11.2.1 Description of communication interface modules

Module	Fieldbus protocol	Description	Functions
CIM 050 	GENIbus TM06 7238 3416	CIM 050 is a Grundfos communication interface module used for communication with a GENIbus network.	CIM 050 has terminals for the GENIbus connection.
CIM 100 	LonWorks TM06 7279 3416	CIM 100 is a Grundfos communication interface module used for communication with a LonWorks network.	CIM 100 has terminals for the LonWorks connection. Two LEDs are used to indicate the actual status of the CIM 100 communication. One LED is used for indication of correct connection to the pump, and the other is used to indicate LonWorks communication status.
CIM 150 	PROFIBUS DP TM06 7280 3416	CIM 150 is a Grundfos communication interface module used for communication with a PROFIBUS network.	CIM 150 has terminals for the PROFIBUS DP connection. DIP switches are used to set line termination. Two hexadecimal rotary switches are used to set the PROFIBUS DP address. Two LEDs are used to indicate the actual status of the CIM 150 communication. One LED is used for indication of correct connection to the pump, and the other is used to indicate PROFIBUS communication status.
CIM 200 	Modbus RTU TM06 7281 3416	CIM 200 is a Grundfos communication interface module used for communication with a Modbus RTU network.	CIM 200 has terminals for the Modbus connection. DIP switches are used to select parity and stop bits, to select transmission speed and to set line termination. Two hexadecimal rotary switches are used to set the Modbus address. Two LEDs are used to indicate the actual status of the CIM 200 communication. One LED is used for indication of correct connection to the pump, and the other is used to indicate Modbus communication status.
CIM 250 	GSM/GPRS TM06 7282 3416	CIM 250 is a Grundfos communication interface module used for GSM or GPRS communication. CIM 250 is used to communicate via a GSM network.	CIM 250 has a SIM-card slot and an SMA connection to the GSM antenna. The CIM 250 also has an internal backup battery. Two LEDs are used to indicate the actual status of the CIM 250 communication. One LED is used for indication of correct connection to the pump, and the other is used to indicate GSM/GPRS communication status. Note: The SIM card is not supplied with the CIM 250. The SIM card from the service provider must support data/fax service to use call service from PC Tool or SCADA. The SIM card from the service provider must support GPRS service to use ethernet service from PC Tool or SCADA.

Module	Fieldbus protocol	Description	Functions
CIM 270 	Grundfos Remote Management TM06 7282 3416	CIM 270 is a Grundfos GSM or GPRS modem used for communication with a Grundfos Remote Management system. It requires a GSM antenna, a SIM card and a contract with Grundfos.	With CIM 270 you have wireless access to your account anywhere, anytime when you have an internet connection, for example via a smartphone, tablet PC, laptop or computer. Warnings and alarms can be sent by e-mail or SMS to your mobile phone or computer. You will get a complete status overview of the entire Grundfos Remote Management system. It allows you to plan maintenance and service based on actual operating data.
CIM 300 	BACnet MS/TP TM06 7281 3416	CIM 300 is a Grundfos communication interface module used for communication with a BACnet MS/TP network.	CIM 300 has terminals for the BACnet MS/TP connection. DIP switches are used to set transmission speed and line termination and to select the custom Device Object Instance Number. Two hexadecimal rotary switches are used to set the BACnet address. Two LEDs are used to indicate the actual status of the CIM 300 communication. One LED is used for indication of correct connection to the pump, and the other is used to indicate BACnet communication status.
CIM 500 	Ethernet TM06 7283 3416	CIM 500 is a Grundfos communication interface module used for data transmission between an industrial ethernet network and a Grundfos product. CIM 500 supports various industrial ethernet protocols: <ul style="list-style-type: none"> • PROFINET • Modbus TCP • BACnet/IP • Ethernet/IP 	CIM 500 supports various industrial ethernet protocols. CIM 500 is configured via the built-in web server, using a standard web browser on a PC. See the specific functional profile on the DVD-ROM supplied with the Grundfos CIM module.

11.2.2 Installing a communication interface module

WARNING

Electric shock



Death or serious personal injury
 - Make sure that other pumps or sources do not force flow through the pump even if the pump is stopped. This will cause the motor to act like a generator, resulting in voltage on the pump.

WARNING

Electric shock





Death or serious personal injury
 - Switch off the power supply for at least 3 minutes before you start any work on the product. Make sure that the power supply cannot be accidentally switched on.
 - It must be possible to lock the main switch in position 0. Type and requirements as specified in EN 60204-1, 5.3.2.



Pumps older than model C must have a CIM module mounted in both the slave and master pump.

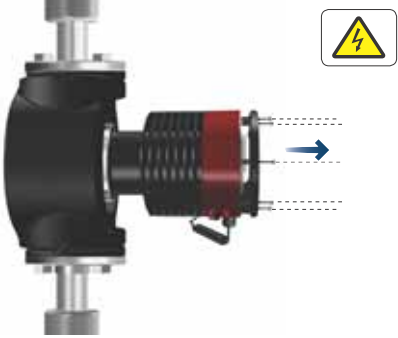

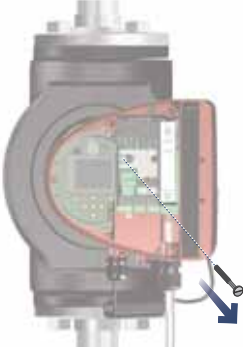
Pumps from model C together with newer versions of CIM modules only requires for the CIM module to be mounted on the master pump, not on the slave. See section [11.2 Communication interface module, CIM](#).

Step	Action	Illustration
1	<p>A. Terminal-connected versions: Remove the front cover from the control box.</p> <p>B. Plug-connected versions: Open the front cover.</p>	<p>A</p>  <p>B</p> 
2	Unscrew the earth connection.	

TM05 2875 3416

TM05 8458 3416

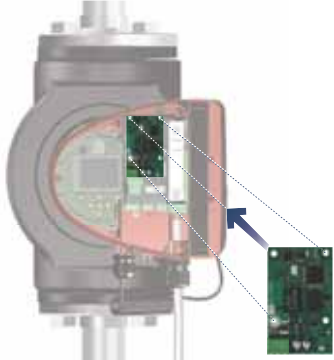
TM06 6907 3416

Step	Action	Illustration
3	Fit the communication interface module as illustrated and click it on.	
4	Tighten the screw holding the communication interface module and secure the earth connection.	
5	For connection to fieldbus networks, see the installation and operating instructions for the desired communication interface module.	

TM05 2914 3416

TM05 2912 3416

TM05 2913 3416

11.2.3 Reuse of communication interface modules

You can reuse a communication interface module in a CIU unit used together with Grundfos MAGNA Series 2000 in MAGNA3. Before you use the CIM module in the pump, reconfigure the module. Contact your nearest Grundfos company.

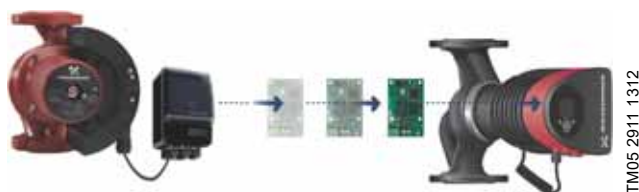

TM05 2911 1312

Fig. 67 Reuse of communication interface module

11.2.4 Auto detection of CIM modules

If a pump in a system with multiple pumps is replaced with a newer version (model D), the new pump automatically detects if the existing pump(s) and/or BMS system are older and adjusts itself accordingly.

Auto detection in twin-head pumps happens if one of the pumps is replaced and paired with a newer model than the existing one, i.e. MAGNA3 model D. The new pump automatically detects the model version of the existing pump. If the old pump is an older model, the new pump will adjust itself making it compatible with the old system.

Auto detection can be manually overruled if the system is controlled by a SCADA system. However, when integrating a newer model with an older setup, we recommend that you choose compatibility mode.

For more information on how to manage auto detection directly on the pump, see section "[Multipump profile selection](#)", page 45.

11.2.5 Grundfos Remote Management

Grundfos Remote Management is an easy-to-install, low-cost solution for wireless monitoring and management of Grundfos products. It is based on a centrally hosted database and a web server with wireless data collection via GSM or GPRS modem. The system only requires an internet connection, a web browser, a Grundfos Remote Management modem and an antenna as well as a contract with Grundfos allowing you to monitor and manage Grundfos pump systems.

You have wireless access to your account anywhere and anytime you have an internet connection, for example via a mobile device. Warnings and alarms can be sent by e-mail or SMS to your mobile device.

Application	Description	Product number
CIM 270	Grundfos Remote Management Requires a contract with Grundfos and a SIM card.	96898815
GSM antenna for roof-mounting	Antenna for use on top of metal cabinets. Vandal-proof. 2-metre cable. Quad band for global use.	97631956
GSM antenna for desk-mounting	Antenna for general-purpose application, for example inside plastic cabinets. To be fixed with the double-adhesive tape supplied. 4-metre cable. Quad band for global use.	97631957

For Grundfos Remote Management contract, contact your local Grundfos company.

11.3 Counterflanges

Counterflange kits consist of two flanges, two gaskets and bolts and nuts, making it possible to install the pump in any pipe. See [MAGNA3 data booklet](#), Accessories section, for the right dimension and product number.

11.4 External sensors

11.4.1 Temperature sensor

Sensor	Type	Measuring range [bar]	Measuring range [°C]	Transmitter output [mA]	Power supply [VDC]	Process connection	Product number
Combined pressure and temperature sensor	RPI T2	0-16	-10 to +120	4-20	12.5 - 30	G 1/2	98355521

11.4.2 Pressure sensor

Sensor	Type	Supplier	Measuring range [bar]	Sensor output [mA]	Power supply [VDC]	Process connection	Product number
Pressure sensor	RPI	Grundfos	0 - 0.6	4-20	12-30	G 1/2	97748907
			0 - 1.0				97748908
			0 - 1.6				97748909
			0 - 2.5				97748910
			0 - 4.0				97748921
			0 - 6.0				97748922
			0-12				97748923
0-16	97748924						

11.4.3 DPI V.2 transmitter

Combined differential-pressure and temperature transmitter

Scope of delivery:

- DPI V.2 transmitter
- open 2 m cable with M12 connection in one end
- capillary tube with fitting
- quick guide.



TM04 7866 2510

Fig. 68 DPI V.2 transmitter

Sensor	Measuring range [bar]	Measuring range [°C]	Transmitter output	Power supply [VDC]	Temperature measurement	O-ring EPDM ¹⁾	Process connection	Product number
Grundfos DPI	0 - 0.6	0-100	4-20 mA	12.5 - 30		•		97747194
			0-10 VDC	16.5 - 30	•	•		97747202
Grundfos DPI	0 - 1.0	0-100	4-20 mA	12.5 - 30		•	G 1/2	97747195
			0-10 VDC	16.5 - 30	•	•		97747203
Grundfos DPI	0 - 1.6	0-100	4-20 mA	12.5 - 30		•	G 1/2	97747196
			0-10 VDC	16.5 - 30	•	•		97747204
Grundfos DPI	0 - 2.5	0-100	4-20 mA	12.5 - 30		•	G 1/2	97747197
			0-10 VDC	16.5 - 30	•	•		97747205

¹⁾ Note: EPDM: approved for potable water.

11.5 Cable for sensors

Description	Length [m]	Product number
Screened cable	2.0	98374260
Screened cable	5.0	98374271

11.6 Blanking flange

A blanking flange is used to blank off the opening when one of the pump heads of a twin-head pump is removed for service to enable uninterrupted operation of the other pump. See fig. 69.

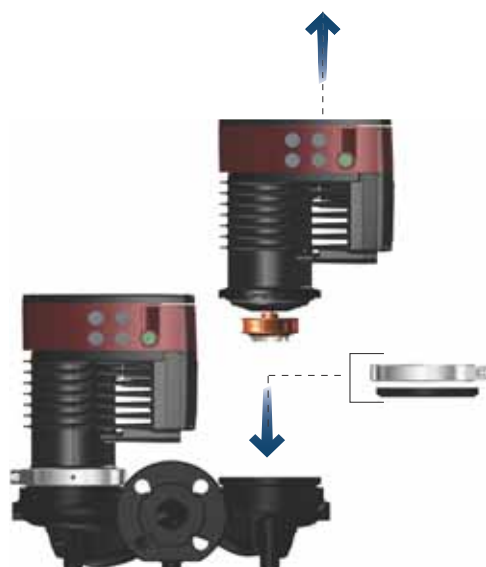

Fig. 69 Position of blanking flange

TM06 8518 0817

Pump type	Product number
MAGNA3 32-40/60/80/100 (F)	98159373
MAGNA3 40-40/60 F	
MAGNA3 32-120 F	98159372
MAGNA3 40-/80/100/120/150/180 F	
MAGNA3 50-40/60/80/100/120/150/180 F	
MAGNA3 65-40/60/80/100/120/150 F	
MAGNA3 80-40/60/80/100/120 F	
MAGNA3 100-40/60/80/100/120 F	

11.7 Insulating kits for air-conditioning and cooling systems

You can fit single-head pumps for air-conditioning and cooling systems with insulating shells. A kit consists of two shells made of polyurethane and a self-adhesive seal to ensure tight assembly.

The dimensions of the insulating shells for pumps in air-conditioning and cooling systems differ from those of the insulating shells for pumps in heating systems.

Pump type	Product number
MAGNA3 25-40/60/80/100/120 (N)	98354534
MAGNA3 32-40/60/80/100/120 (N)	98354535
MAGNA3 32-40/60/80/100 F (N)	98354536
MAGNA3 32-120 F (N)	98063287
MAGNA3 40-40/60 F (N)	98354537
MAGNA3 40-80/100 F (N)	98063288
MAGNA3 40-120/150/180 F (N)	98145675
MAGNA3 50-40/60/80 F (N)	98063289
MAGNA3 50-100/120/150/180 F (N)	98145676
MAGNA3 65-40/60/80/100/120 F (N)	96913593
MAGNA3 80-40/60/80/100/120 F	98134265
MAGNA3 100-40/60/80/100/120 F	96913589

Insulating shells for single-head pumps for heating systems are supplied with the pump.

12. Technical data

Supply voltage

1 x 230 V ± 10 %, 50/60 Hz, PE.

Motor protection

The pump requires no external motor protection.

Enclosure class

IPX4D (EN 60529).

Insulation class

F.

Relative humidity

Maximum 95 %.

Ambient temperature

0 to +40 °C.

During transport: -40 to +70 °C.

Temperature class

TF110 (EN 60335-2-51).

Liquid temperature

Continuously: -10 to +110 °C.

Stainless-steel pumps in domestic hot-water systems:

In domestic hot-water systems, we recommend that you keep the liquid temperature below 65 °C to eliminate the risk of lime precipitation.

System pressure



The actual inlet pressure and the pump pressure against a closed valve must be lower than the maximum permissible system pressure.

The maximum permissible system pressure is stated on the pump nameplate:

PN 6: 6 bar / 0.6 MPa

PN 10: 10 bar / 1.0 MPa

PN 16: 16 bar / 1.6 MPa.

Test pressure

The pumps can withstand test pressures as indicated in EN 60335-2-51. See below.

- PN 6: 7.2 bar
- PN 10: 12 bar
- PN 6/10: 12 bar
- PN 16: 19.2 bar.

During normal operation, do not use the pump at higher pressures than those stated on the nameplate.

The pressure test has been made with water containing anticorrosive additives at a temperature of 20 °C.

Minimum inlet pressure

The following relative minimum inlet pressure must be available at the pump inlet during operation to avoid cavitation noise and damage to the pump bearings.



The values in the table below apply to single-head pumps and twin-head pumps in single-head operation.

MAGNA3	Liquid temperature		
	75 °C	95 °C	110 °C
	Inlet pressure [bar] / [MPa]		
25-40/60/80/100/120	0.10 / 0.01	0.35 / 0.035	1.0 / 0.10
32-40/60/80/100/120	0.10 / 0.01	0.35 / 0.035	1.0 / 0.10
32-40/60/80/100/120 F	0.10 / 0.01	0.35 / 0.035	1.0 / 0.10
32-120 F	0.10 / 0.01	0.20 / 0.020	0.7 / 0.07
40-40/60 F	0.10 / 0.01	0.35 / 0.035	1.0 / 0.10
40-80/100/120/150/180 F	0.10 / 0.01	0.50 / 0.05	1.0 / 0.10
50-40/60/80 F	0.10 / 0.01	0.40 / 0.04	1.0 / 0.10
50-100/120 F	0.10 / 0.01	0.50 / 0.05	1.0 / 0.10
50-150/180 F	0.70 / 0.07	1.20 / 0.12	1.7 / 0.17
65-40/60/80/100/120/150 F	0.70 / 0.07	1.20 / 0.12	1.7 / 0.17
80-40/60/80/100/120 F	0.50 / 0.05	1.00 / 0.10	1.5 / 0.15
100-40/60/80/100/120 F	0.70 / 0.07	1.20 / 0.12	1.7 / 0.17

In the case of cascade operation, the required relative inlet pressure must be increased by 0.1 bar / 0.01 MPa compared to the stated values for single-head pumps or twin-head pumps in single-head operation.

The relative minimum inlet pressures apply to pumps installed up to 300 metres above sea level. For altitudes above 300 metres, the required relative inlet pressure must be increased by 0.01 bar / 0.001 MPa per 100 metres altitude. The MAGNA3 pump is only approved for an altitude of 2000 metres above sea level.

Sound pressure level

The sound pressure level of the pump is dependent on the power consumption. Levels are determined in accordance with ISO 3745 and ISO 11203, method Q2.

Pump size	Max. dB(A)
25-40/60/80/100/120	39
32-40/60/80/100/120	
40-40/60	
50-40	
32-120 F	45
40-80/100	
50-60/80	
65-40/60	
80-40	50
40-120/150/180	
50-100/120/150/180	
65-80/100/120	
80-60/80	55
100-40/60	
65-150	
80-100/120	55
100-80/100/120	

Leakage current

The mains filter will cause a leakage current to earth during operation. The leakage current is less than 3.5 mA.

Consumption when the pump is stopped

4 to 10 W, depending on activity, such as reading the display, use of Grundfos GO, interaction with modules.

4 W when the pump is stopped and there is no activity.

Input and output communication

Two digital inputs	External potential-free contact. Contact load: 5 V, 10 mA. Screened cable. Loop resistance: Maximum 130 Ω.
Analog input	4-20 mA, load: 150 Ω. 0-10 VDC, load: Greater than 10 kΩ.
Two relay outputs	Internal potential-free changeover contact. Maximum load: 250 V, 2 A, AC1. Minimum load: 5 VDC, 20 mA. Screened cable, depending on signal level.
24 VDC supply	Maximum load: 22 mA. Capacitive load: Less than 470 µF.

Cable glands

Use M16 cable glands for the input and output connections (not supplied with the pump).

Power factor

The terminal-connected versions have built-in an active power factor correction which gives a cos φ from 0.98 to 0.99.

The plug-connected versions have built-in passive PFC, with coil and resistors which ensures that the current drawn from the grid is in phase with the voltage. The current is approximately sinusoidal which gives a cos φ from 0.55 to 0.98.

12.1 Sensor specifications

12.1.1 Temperature

Temperature range during operation	Accuracy
-10 to +35 °C	± 4 °C
+35 to +90 °C	± 2 °C
+90 to +110 °C	± 4 °C

13. Disposing of the product

This product has been designed with focus on the disposal and recycling of materials. The following average disposal values apply to all variants of pumps:

- 85 % recycling
- 10 % incineration
- 5 % depositing.

This product or parts of it must be disposed of in an environmentally sound way:

1. Use the public or private waste collection service.
2. If this is not possible, contact the nearest Grundfos company or service workshop.



The crossed-out wheellie bin symbol on a product means that it must be disposed of separately from household waste. When a product marked with this symbol reaches its end of life, take it to a collection point designated by the local waste disposal

authorities. The separate collection and recycling of such products will help protect the environment and human health.

See also end-of-life information at www.grundfos.com/product-recycling.

WARNING

Magnetic field



Death or serious personal injury

- Persons with pacemakers disassembling this product must exercise care when handling the magnetized materials embedded in the rotor.

Appendix

Dimensions

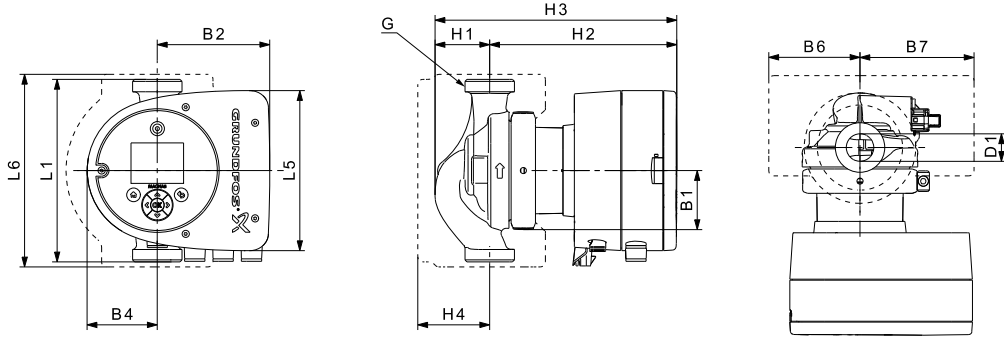

Fig. 1 Dimensions, single-head pumps, threaded versions

TM05 7938 2013

Pump type	Dimensions [mm]													
	L1	L5	L6	B1	B2	B4	B6	B7	H1	H2	H3	H4	D1	G
MAGNA3 25-40 (N)	180	158	190	58	111	69	90	113	54	185	239	71	25	1 1/2
MAGNA3 25-60 (N)	180	158	190	58	111	69	90	113	54	185	239	71	25	1 1/2
MAGNA3 25-80 (N)	180	158	190	58	111	69	90	113	54	185	239	71	25	1 1/2
MAGNA3 25-100 (N)	180	158	190	58	111	69	90	113	54	185	239	71	25	1 1/2
MAGNA3 25-120 (N)	180	158	190	58	111	69	90	113	54	185	239	71	25	1 1/2
MAGNA3 32-40 (N)	180	158	190	58	111	69	90	113	54	185	239	71	32	2
MAGNA3 32-60 (N)	180	158	190	58	111	69	90	113	54	185	239	71	32	2
MAGNA3 32-80 (N)	180	158	190	58	111	69	90	113	54	185	239	71	32	2
MAGNA3 32-100 (N)	180	158	190	58	111	69	90	113	54	185	239	71	32	2
MAGNA3 32-120 (N)	180	158	190	58	111	69	90	113	54	185	239	71	32	2

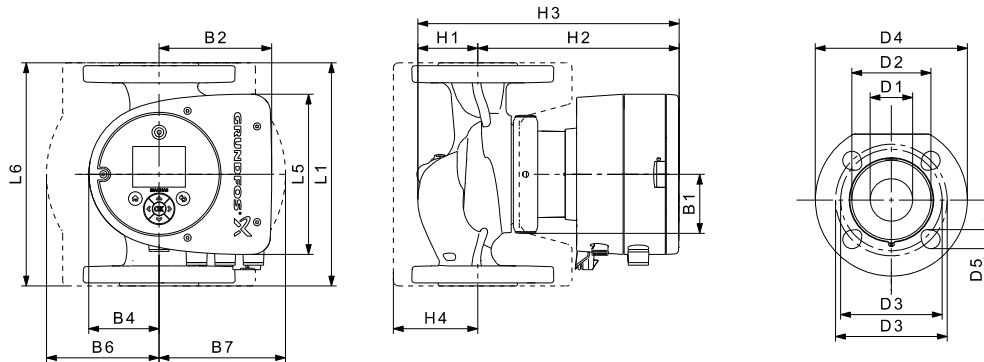

Fig. 2 Dimensions, single-head pumps, flanged versions

TM05 7938 2013

Pump type	Dimensions [mm]																
	L1	L5	L6	B1	B2	B4	B6	B7	H1	H2	H3	H4	D1	D2	D3	D4	D5
MAGNA3 32-40 F (N)	220	158	220	58	111	69	100	110	65	185	250	82	32	76	90/100	140	14/19
MAGNA3 32-60 F (N)	220	158	220	58	111	69	100	110	65	185	250	82	32	76	90/100	140	14/19
MAGNA3 32-80 F (N)	220	158	220	58	111	69	100	110	65	185	250	82	32	76	90/100	140	14/19
MAGNA3 32-100 F (N)	220	158	220	58	111	69	100	110	65	185	250	82	32	76	90/100	140	14/19
MAGNA3 40-40 F (N)	220	158	220	58	111	69	105	105	65	199	264	83	40	84	100/110	150	14/19
MAGNA3 40-60 F (N)	220	158	220	58	111	69	105	105	65	199	264	83	40	84	100/110	150	14/19

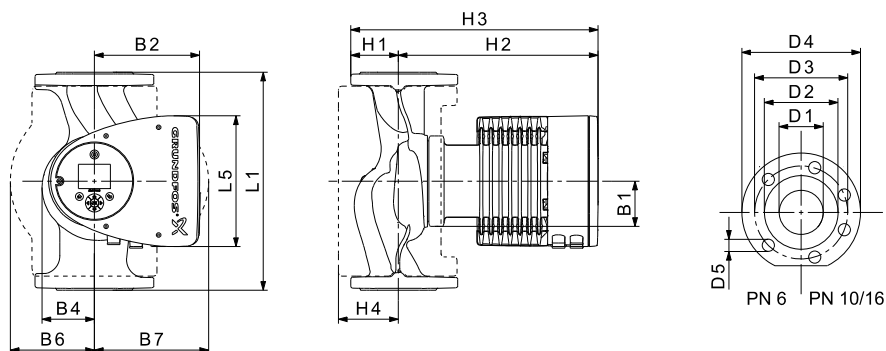

Fig. 3 Dimensions, single-head pumps, flanged versions

TM05 5291 2013

Pump type	Dimensions [mm]															
	L1	L5	B1	B2	B4	B6	B7	H1	H2	H3	H4	D1	D2	D3	D4	D5
MAGNA3 32-120 F (N)	220	204	84	164	73	106	116	65	301	366	86	32	76	90/100	140	14/19
MAGNA3 40-80 F (N)	220	204	84	164	73	106	128	65	304	369	83	40	84	100/110	150	14/19
MAGNA3 40-100 F (N)	220	204	84	164	73	106	128	65	304	369	83	40	84	100/110	150	14/19
MAGNA3 40-120 F (N)	250	204	84	164	73	106	128	65	304	369	83	40	84	100/110	150	14/19
MAGNA3 40-150 F (N)	250	204	84	164	73	106	128	65	304	369	83	40	84	100/110	150	14/19
MAGNA3 40-180 F (N)	250	204	84	164	73	106	128	65	304	369	83	40	84	100/110	150	14/19
MAGNA3 50-40 F (N)	240	204	84	164	73	127	127	71	304	374	97	50	102	110/125	165	14/19
MAGNA3 50-60 F (N)	240	204	84	164	73	127	127	71	304	374	97	50	102	110/125	165	14/19
MAGNA3 50-80 F (N)	240	204	84	164	73	127	127	71	304	374	97	50	102	110/125	165	14/19
MAGNA3 50-100 F (N)	280	204	84	164	73	127	127	72	304	376	97	50	102	110/125	165	14/19
MAGNA3 50-120 F (N)	280	204	84	164	73	127	127	72	304	376	97	50	102	110/125	165	14/19
MAGNA3 50-150 F (N)	280	204	84	164	73	127	127	72	304	376	97	50	102	110/125	165	14/19
MAGNA3 50-180 F (N)	280	204	84	164	73	127	127	72	304	376	97	50	102	110/125	165	14/19
MAGNA3 65-40 F (N)	340	204	84	164	73	133	133	74	312	386	94	65	119	130/145	185	14/19
MAGNA3 65-60 F (N)	340	204	84	164	73	133	133	74	312	386	94	65	119	130/145	185	14/19
MAGNA3 65-80 F (N)	340	204	84	164	73	133	133	74	312	386	94	65	119	130/145	185	14/19
MAGNA3 65-100 F (N)	340	204	84	164	73	133	133	74	312	386	94	65	119	130/145	185	14/19
MAGNA3 65-120 F (N)	340	204	84	164	73	133	133	74	312	386	94	65	119	130/145	185	14/19
MAGNA3 65-150 F (N)	340	204	84	164	73	133	133	74	312	386	94	65	119	130/145	185	14/19
MAGNA3 80-40 F	360	204	84	164	73	163	163	96	318	413	115	80	128	150/160	200	19
MAGNA3 80-60 F	360	204	84	164	73	163	163	96	318	413	115	80	128	150/160	200	19
MAGNA3 80-80 F	360	204	84	164	73	163	163	96	318	413	115	80	128	150/160	200	19
MAGNA3 80-100 F	360	204	84	164	73	163	163	96	318	413	115	80	128	150/160	200	19
MAGNA3 80-120 F	360	204	84	164	73	163	163	96	318	413	115	80	128	150/160	200	19
MAGNA3 100-40 F	450	204	84	164	73	178	178	103	330	433	120	100	160	170	220	19
MAGNA3 100-60 F	450	204	84	164	73	178	178	103	330	433	120	100	160	170	220	19
MAGNA3 100-80 F	450	204	84	164	73	178	178	103	330	433	120	100	160	170	220	19
MAGNA3 100-100 F	450	204	84	164	73	178	178	103	330	433	120	100	160	170	220	19
MAGNA3 100-120 F	450	204	84	164	73	178	178	103	330	433	120	100	160	170	220	19

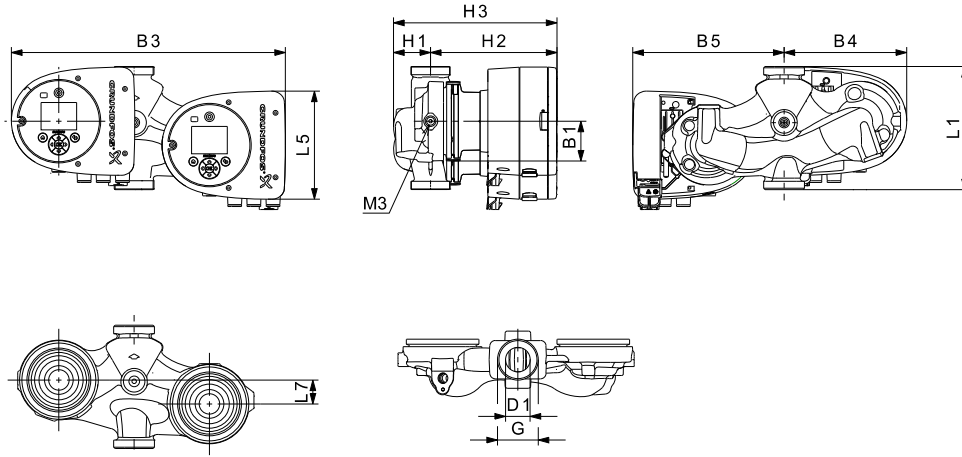

Fig. 4 Dimensions, twin-head pumps, threaded versions

TM05 7939 2013

Pump type	Dimensions [mm]												
	L1	L5	L7	B1	B3	B4	B5	H1	H2	H3	D1	G	M3
MAGNA3 D 32-40	180	158	35	58	400	179	221	54	185	239	32	2	1/4
MAGNA3 D 32-60	180	158	35	58	400	179	221	54	185	239	32	2	1/4
MAGNA3 D 32-80	180	158	35	58	400	179	221	54	185	239	32	2	1/4
MAGNA3 D 32-100	180	158	35	58	400	179	221	54	185	239	32	2	1/4

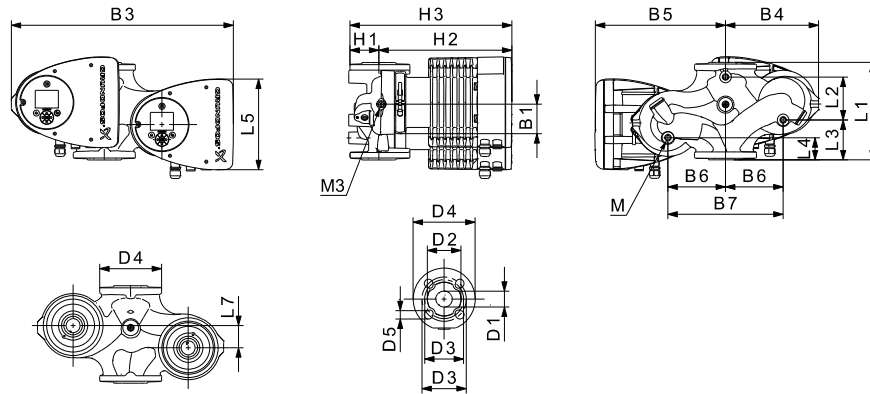

Fig. 5 Dimensions, twin-head pumps, flanged versions

TM05 5294 3612

Pump type	Dimensions [mm]																					
	L1	L2	L3	L4	L5	L7	B1	B3	B4	B5	B6	B7	H1	H2	H3	D1	D2	D3	D4	D5	M	M3
MAGNA3 D 32-40 F	220	73	120	85	158	35	58	400	179	221	130	260	69	185	254	32	76	90/100	140	14/19	M12	Rp 1/4
MAGNA3 D 32-60 F	220	73	120	85	158	35	58	400	179	221	130	260	69	185	254	32	76	90/100	140	14/19	M12	Rp 1/4
MAGNA3 D 32-80 F	220	73	120	85	158	35	58	400	179	221	130	260	69	185	254	32	76	90/100	140	14/19	M12	Rp 1/4
MAGNA3 D 32-100 F	220	73	120	85	158	35	58	400	179	221	130	260	69	185	254	32	76	90/100	140	14/19	M12	Rp 1/4
MAGNA3 D 32-120 F	220	97	90	50	204	50	84	502	210	294	130	260	68	300	368	32	76	90/100	140	14/19	M12	Rp 1/4
MAGNA3 D 40-40 F	220	53	140	60	158	15	58	452	211	241	130	260	76	199	275	40	84	100/110	150	14/19	M12	Rp1/4
MAGNA3 D 40-60 F	220	53	140	60	158	15	58	452	211	241	130	260	76	199	275	40	84	100/110	150	14/19	M12	Rp1/4
MAGNA3 D 40-80 F	220	53	140	60	204	15	84	502	210	294	130	260	76	303	379	40	84	100/110	150	14/19	M12	Rp 1/4
MAGNA3 D 40-100 F	220	53	140	60	204	15	84	502	210	294	130	260	76	303	379	40	84	100/110	150	14/19	M12	Rp 1/4
MAGNA3 D 50-40 F	240	48	160	45	204	45	84	515	221	294	130	260	75	304	379	50	102	110/125	165	14/19	M12	Rp 1/4
MAGNA3 D 50-60 F	240	48	160	45	204	45	84	515	221	294	130	260	75	304	379	50	102	110/125	165	14/19	M12	Rp 1/4
MAGNA3 D 50-80 F	240	48	160	45	204	45	84	515	221	294	130	260	75	304	379	50	102	110/125	165	14/19	M12	Rp 1/4

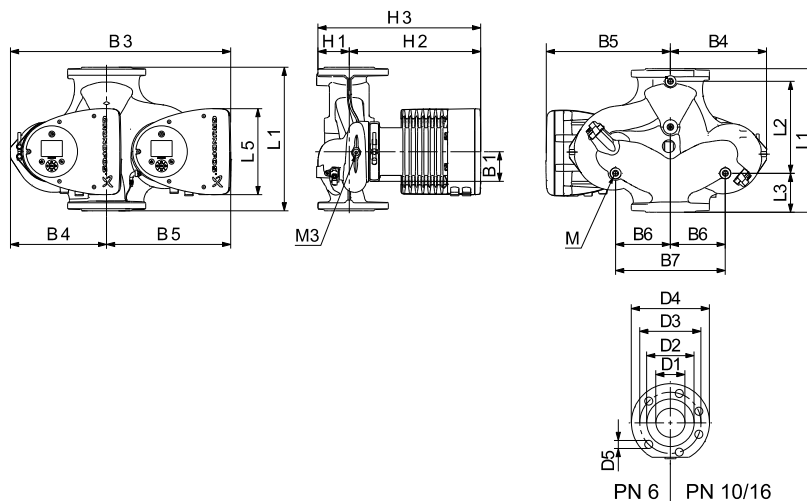

Fig. 6 Dimensions, twin-head pumps

TM05 5366 2013

Pump type	Dimensions [mm]																				
	L1	L2	L3	L4	L5	B1	B3	B4	B5	B6	B7	H1	H2	H3	D1	D2	D3	D4	D5	M	M3
MAGNA3 D 40-120 F	250	58	155	75	204	84	512	220	294	130	260	69	303	372	40	84	100/110	150	14/19	M12	Rp 1/4
MAGNA3 D 40-150 F	250	58	155	75	204	84	512	220	294	130	260	69	303	372	40	84	100/110	150	14/19	M12	Rp 1/4
MAGNA3 D 40-180 F	250	58	155	75	204	84	512	220	294	130	260	69	303	372	40	84	100/110	150	14/19	M12	Rp 1/4
MAGNA3 D 50-100 F	280	175	75	75	204	84	517	223	294	130	260	75	304	379	50	102	110/125	165	14/19	M12	Rp 1/4
MAGNA3 D 50-120 F	280	175	75	75	204	84	517	223	294	130	260	75	304	379	50	102	110/125	165	14/19	M12	Rp 1/4
MAGNA3 D 50-150 F	280	175	75	75	204	84	517	223	294	130	260	75	304	379	50	102	110/125	165	14/19	M12	Rp 1/4
MAGNA3 D 50-180 F	280	175	75	75	204	84	517	223	294	130	260	75	304	379	50	102	110/125	165	14/19	M12	Rp 1/4
MAGNA3 D 65-40 F	340	218	92	92	204	84	522	228	294	130	260	77	312	389	65	119	130/145	185	14/19	M12	Rp 1/4
MAGNA3 D 65-60 F	340	218	92	92	204	84	522	228	294	130	260	77	312	389	65	119	130/145	185	14/19	M12	Rp 1/4
MAGNA3 D 65-80 F	340	218	92	92	204	84	522	228	294	130	260	77	312	389	65	119	130/145	185	14/19	M12	Rp 1/4
MAGNA3 D 65-100 F	340	218	92	92	204	84	522	228	294	130	260	77	312	389	65	119	130/145	185	14/19	M12	Rp 1/4
MAGNA3 D 65-120 F	340	218	92	92	204	84	522	228	294	130	260	77	312	389	65	119	130/145	185	14/19	M12	Rp 1/4
MAGNA3 D 65-150 F	340	218	92	92	204	84	522	228	294	130	260	77	312	389	65	119	130/145	185	14/19	M12	Rp 1/4
MAGNA3 D 80-40 F	360	218	102	102	204	84	538	244	294	130	260	97	318	415	80	128	150/160	200	19	M12	Rp 1/4
MAGNA3 D 80-60 F	360	218	102	102	204	84	538	244	294	130	260	97	318	415	80	128	150/160	200	19	M12	Rp 1/4
MAGNA3 D 80-80 F	360	218	102	102	204	84	538	244	294	130	260	97	318	415	80	128	150/160	200	19	M12	Rp 1/4
MAGNA3 D 80-100 F	360	218	102	102	204	84	538	244	294	130	260	97	318	415	80	128	150/160	200	19	M12	Rp 1/4
MAGNA3 D 80-120 F	360	218	102	102	204	84	538	244	294	130	260	97	318	415	80	128	150/160	200	19	M12	Rp 1/4
MAGNA3 D 100-40 F	450	243	147	147	204	84	551	252	299	135	270	103	330	434	100	160	170	220	19	M12	Rp 1/4
MAGNA3 D 100-60 F	450	243	147	147	204	84	551	252	299	135	270	103	330	434	100	160	170	220	19	M12	Rp 1/4
MAGNA3 D 100-80 F	450	243	147	147	204	84	551	252	299	135	270	103	330	434	100	160	170	220	19	M12	Rp 1/4
MAGNA3 D 100-100 F	450	243	147	147	204	84	551	252	299	135	270	103	330	434	100	160	170	220	19	M12	Rp 1/4
MAGNA3 D 100-120 F	450	243	147	147	204	84	551	252	299	135	270	103	330	434	100	160	170	220	19	M12	Rp 1/4

Flange forces and moments

Maximum permissible forces and moments from the pipe connections acting on the pump flanges or threaded connections are indicated in fig. 7.

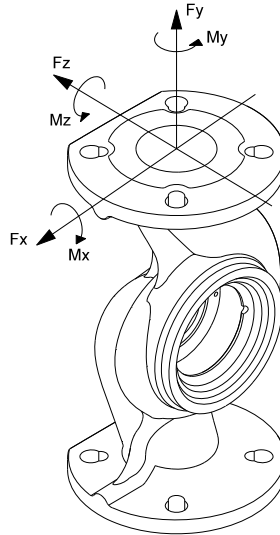

Fig. 7 Forces and moments from the pipe connections acting on the pump flanges or threaded connections

TM05 5639 4012

Diameter DN	Force [N]				Moment [Nm]			
	Fy	Fz	Fx	ΣF_b	My	Mz	Mx	ΣM_b
25*	350	425	375	650	300	350	450	650
32*	425	525	450	825	375	425	550	800
40	500	625	550	975	450	525	650	950
50	675	825	750	1300	500	575	700	1025
65	850	1050	925	1650	550	600	750	1100
80	1025	1250	1125	1975	575	650	800	1175
100	1350	1675	1500	2625	625	725	875	1300

* The values also apply to pumps with threaded connection.

The above values apply to cast-iron versions. For stainless-steel versions, the values can be multiplied by two according to the ISO 5199 standard.

Tightening torques for bolts

Recommended tightening torques for bolts used in flanged connections:

Bolt dimension	Torque
M12	27 Nm
M16	66 Nm

1. 中国RoHS

产品中有害物质的名称及含量

部件名称	有害物质					
	铅 (Pb)	汞 (Hg)	镉 (Cd)	六价铬 (Cr6+)	多溴联苯 (PBB)	多溴联苯醚 (PBDE)
泵壳	X	0	0	0	0	0
印刷电路板	X	0	0	0	0	0
紧固件	X	0	0	0	0	0
管件	X	0	0	0	0	0
定子	X	0	0	0	0	0
转子	X	0	0	0	0	0

本表格依据 SJ/T 11364 的规定编制

O: 表示该有害物质在该部件所有均质材料中的含量均在 GB/T 26572 规定的限量要求以下。

X: 表示该有害物质至少在该部件的某一均质材料中的含量超出 GB/T 26572 该规定的限量要求。



该产品环保使用期限为 10 年，标识如左图所示。

此环保期限只适用于产品在安装与使用说明书中所规定的条件下工作

98091805 0719

ECM: 1265030

Trademarks displayed in this material, including but not limited to Grundfos, the Grundfos logo and "be think innovate" are registered trademarks owned by The Grundfos Group. All rights reserved. © 2019 Grundfos Holding A/S, all rights reserved.